

Consumer Price List #38

Effective January 1, 2022



Simon frame and tile system. page 1

Suzy freestanding desk system page 75

Tables page 113

Trek page 123

Filing page 129



frame and tile system

Consumer Price List #38 – Effective January 1, 2022





frame and tile system

product overview	page 4
standard tiles	page 6
panel specification	page 8
support and load guidelines	page 10
panel - frame & tiles	page 11
frames and crossmembers ordered separately	page 18
tiles ordered separately & tile knockouts	page 19
top caps and end caps	page 20
panel connectors	page 22
door units	page 26
power towers	page 27
electrical components	page 28
tile knockout guide	page 31

scallops & grommets	page 32
workspace edge selection guide	page 33
worksurfaces	page 34
keyboards & workspace accessories	page 50
countertops	page 52
workspace support components: cantilevers, clamps, c-legs & end panels	page 58
pedestal & 2-drawer laterals	page 60
personal locker	page 63
storage bins	page 64
tasks lights	page 64
wall mount components	page 66
super acoustic frame pillows	page 67
panel weight index	page 68



tiles

Snap and Lock – Tiles snap-in-place and self-lock. . . tiles are removed only when you want them removed.

Durability – All steel construction can withstand abuse and allows for repair.

Sewn Fabric – Not glued; field replaceable; recyclable.

Highest Acoustic Rating – NRC (noise reduction coefficient) = .95

frames

Installer Friendly – Frames attach using a single draw-rod system. Installation is quick and easy.

Solid Steel Construction – Frames are factory welded for light weight strength and rigidity.

top caps and end caps

Steel Construction – Secured with bolts; no service calls for replacement.

power & voice/data cables

Lay-in Cabling – 3/4" space between frame and tile facilitates our exclusive lay-in feature; no fishing cables through holes, no need for troublesome raceways.

Terminate Power and Voice/Data Anywhere – Another Simon exclusive.

Power Poles – Integrate beautifully into top of panel at almost any location. Dual chamber - high capacity. Simultaneous capacity: 6 electrical feeds, 180 voice/data cables.

environmentally friendly

Sustainability – Simon is constructed of heavy gauge domestic steel and is therefore recyclable.

Sewn Construction – All fabric tiles are adhesive free and therefore emit no fumes at the factory or the installation site. This unique upholstery technique allows for simple material separation for re-upholstery or recycling.

Low Waste Manufacturing Process – Every pound of steel scrap generated in fabricating Simon is recycled. Remnant upholstery materials are used for acoustic pillows.

installation support

Dedicated Factory Support – Customer requested field changes and punch lists are handled quickly.

Detailed Installation Drawings – Shipped with each order.

Accessibility – Factory personnel always available to train your installers.

legacy integration / scalability

Engineered to Integrate with Most Panel Systems – Use as a spine on legacy systems to create a low cost upgrade to an existing job.

Low Cost Tile Options – To fit in any budget.



The **Simon Series™ Panel System** from McDowell-Craig is a true stand out among tiled panel systems. The first of its kind to offer true lay-in cable capability, all-steel tile construction and the highest acoustic rating available at a .95 NRC.

features

tiles

Installer friendly, factory assembled tiles go straight from the shipping box to the frame with a simple snap-in-place attachment system. All steel construction can withstand abuse and allows for field repair. Sewn construction allows for field replacement of tile fabric and recycling of discarded material. Simon tiles provide the highest acoustic rating available with a Noise Reduction Coefficient of .95.

open design internal frames

Simon frames are designed to adapt to emerging technologies. One key component to this premise is true lay-in cabling ability accommodated by a large spacing between frame and tile. This open design allows power and voice/data to terminate anywhere within the system making Simon equally effective on installations that have minimal or very high technological demands. In addition, the all-steel construction of these frames provides a rock-solid foundation for worksurfaces and panel mounted storage bins.

trim

Steel constructed and secured with bolts, standard Simon top caps and end caps are engineered for high use without service calls for replacement.

panel mounted storage

Panel mounted storage bins are a versatile solution for quick reference storage. Panel mounted storage bins are available in enamel and feature an optional lock.

under-worksurface storage

McDowell-Craig's 65-plus year reputation for quality has always been spear-headed by the highest quality storage and filing available. This reputation for quality is clearly seen in the Simon pedestals and S Series lateral files. Built to last a lifetime, these products are engineered to remain square, and in excellent working condition for decades.

keyboards and accessories

A wide variety of keyboard arms and platforms facilitate correct ergonomic configurations and are completely compatible with Simon worksurface configurations.

environmentally friendly

Simon Series frames, tiles and components are constructed of heavy gauge domestic steel and are 100% recyclable. All fabric tiles are adhesive free and emit no fumes at the factory or the installation site. This unique upholstery technique allows for simple material separation during re-upholstery or recycling. Every pound of steel scrap used in fabricating Simon is recycled. In addition, remnant upholstery materials are utilized for making acoustic pillows, used in conjunction with super acoustic tiles.

finishes

coatings

Standard Coating — Simon Series frames, tiles, connectors, storage bins, open shelves, pedestals, and components are available in a variety of coatings.

Special Coating — Simon Series tiles, connectors, storage bins, open shelves, pedestals, and components may be ordered in factory approved special coatings — add 8% to price of unit (e.g. pedestals, tiles, etc.) + \$1136 set-up and mixing charge per color per order. Note: Written factory approval must accompany your purchase order.

laminates

Standard Laminates — A variety of laminate patterns, solids, textures, metallic and wood grains are available.

See *McDowell-Craig Plastic Laminates Selection Guide* for standard selections.

Special Laminates — Simon Series worksurfaces may also be ordered with special laminates — add 8% to price of unit (e.g. worksurfaces) + \$701 per laminate pattern per order. Note: Written factory approval must accompany your purchase order.

fabrics

All fabric pricing for tiles is based on Grade I fabrics. See *McDowell-Craig Fabric Selection Guide*.

For other Grade I fabrics add 8% to price of unit (e.g. tile, tackboard) + \$191 per fabric pattern per order.

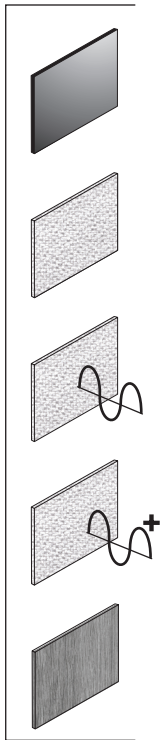

single-sided

**enamel/coated – “E”**

Enamel/coated tiles are economical and easy to clean. Best choice for going against walls. Available in multiple colors.

fabric – “F”

Fabric tiles are fully recyclable, sewn constructed grade I fabric over coated finished steel tile. Available in multiple standard fabrics, see *Fabric Selection Guide*.

acoustic – “A”

Acoustic tiles are tackable, sewn constructed grade I fabric over coated finished steel tile with sound deadening acoustical insert. NRC rating of .60. Available in multiple standard fabrics, see *Fabric Selection Guide*.

super acoustic – “S”

Acoustic tiles are tackable, sewn constructed grade I fabric over coated finished perforated steel tile with sound deadening acoustical insert. The addition of an acoustical pillow placed inside the frame assembly achieves an NRC rating of .95, making it the best in the industry. Available in multiple standard fabrics, see *Fabric Selection Guide*.

laminate – “L”

Laminate tiles are vertical grade laminate over coated finished steel tile. Good choice for high traffic areas. Easy to clean. Available in multiple standard laminates, see *Laminate Selection Guide*.

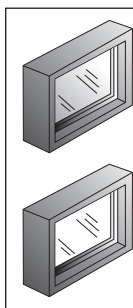
2-sided
specify inside only**plexiglass, frosted – “R”**

Single pane, 1/4" frosted plexiglass with architectural glass-like tint. Available in multiple colors.

plexiglass, clear – “C”

Single pane, 1/4" clear plexiglass. Trim available in multiple colors.

specialty tiles

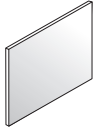

marker board tile – “M”

Marker board laminate over enamel finished steel tile.

Price as an acoustic tile (“A”).

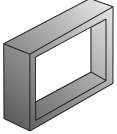

open frame – “O”

Complete finished component of a Simon frame. Trim available in multiple colors. Price as a clear plexi tile “C”.



panel specification

step 1: panel dimension - determine panel height and width

step 2: tile configuration - select inside and outside tile configuration and then place tiles in the desired order (see charts below)

step 3: tile types - determine tile type for inside and outside of panel (see pp 6-7)

step 4: panel price - use the panel component charts (see pp 11-17) to find the appropriate pricing

step 1 – panel dimensions

panel size chart

Simon panels: height in 7" increments and width in 6" increments.

minimum size: 35" h x 20" w

maximum size: 105" h x 54" w

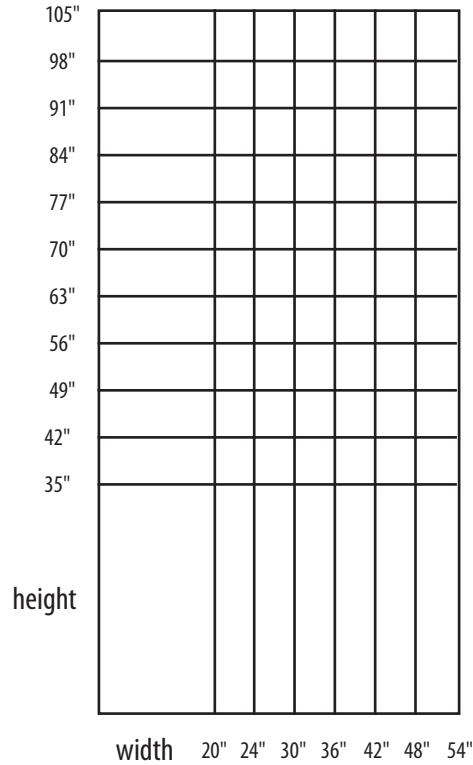

step 2 – tile configuration

tile size chart

Heights: 7", 14", 21", 28" and 35".

Tile #: based on it's multiple of 7.

example: $35 \div 7 = 5$

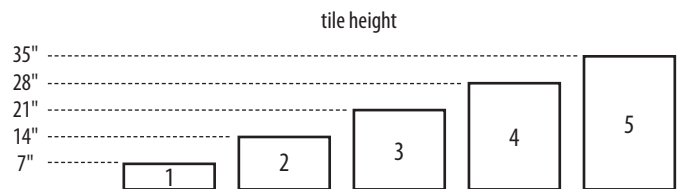

inside & outside tiles – unequal:

placing tiles and specifying panel number

Use the tile # (1 thru 5) to configure the tile array of a panel.

example: 63" high x 24" wide panel model number...

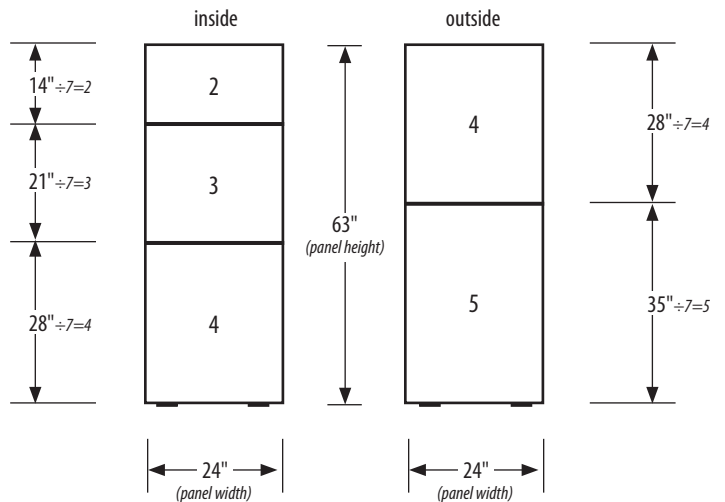
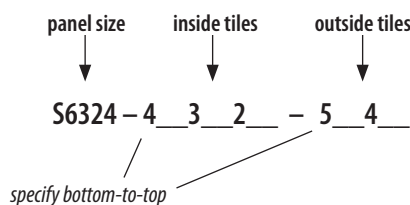

inside & outside tiles – equal:

placing tiles and specifying panel number

Use the tile # (1 thru 5) to configure the tile array of a panel.

example: 63" high x 24" wide panel model number...

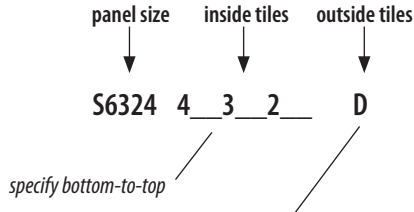

specify bottom-to-top

"D" stands for double and signifies that the inside tile configuration equals the outside tile configuration.

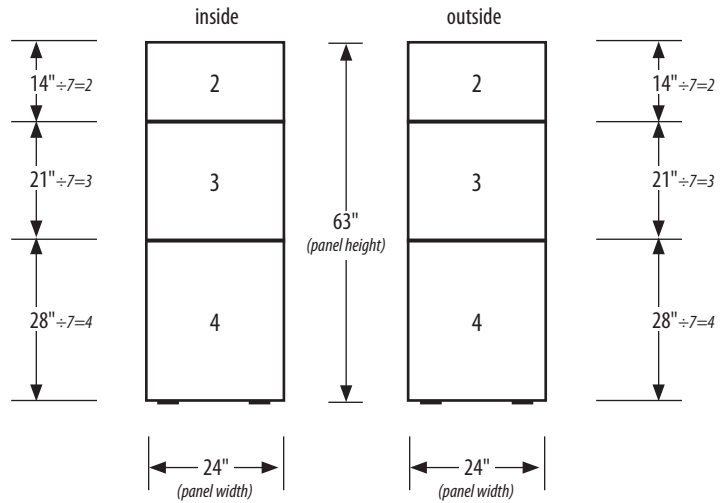

step 3 – tile types

specifying tiles

Add the letter values (E, F, A, etc.) to the corresponding tile number.

example: 63" high x 24" wide panel model number...

Model #	w	h	lbs	"E" Enamel	"F" Fabric	"A" Acoustic	"S" Acoustic+	"L" Laminate	"N" None	"R" Frosted	"C" Clear Plexi
T-0724_	24"	7"=1	2	\$35	\$46	\$62	\$65	\$48	N/C	\$217	\$182

2-sided tiles – specify inside only



step 4 – pricing

specifying panel price

Use the panel component charts (see pp 7-13) to find the appropriate pricing.

example: 63" high x 24" wide panel model #S6324 – 4F3A2A – 5E4E

S6324
(tile # total=9)

24" wide frames

Model #	w	h	lbs	list price
S3524	24"	35"	13	\$190
S4224	24"	42"	15	215
S4924	24"	49"	16	247
S5624	24"	56"	18	263
S6324	24"	63"	21	304
S7024	24"	70"	23	352

24" wide tiles

Model #	w	h	lbs	"E" Enamel	"F" Fabric	"A" Acoustic	"S" Acoustic+
T-0724_	24"	7"=1	2	\$35	\$46	\$62	\$65
T-1424_	24"	14"=2	4	48	69	96	107
T-2124_	24"	21"=3	6	65	87	126	142
T-2824_	24"	28"=4	7	76	111	161	182
T-3524_	24"	35"=5	9	94	138	208	231

S6324 4F3A2A 5E4E

\$304 \$111 \$126 \$96 \$94 \$76 **total = \$807**

step 5 – description

describe the final panel

example: panel model #S6324 – 4F3A2A – 5E4E

description → 63" h x 24" w panel



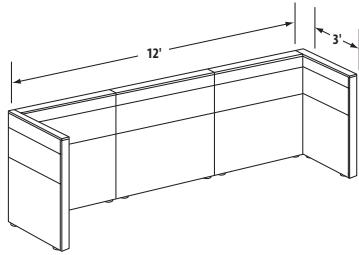

single sided returns –

A straight run of Simon panels can extend up to 12' when supported at both ends by 36" (minimum) return panels. Return panels must be the same height as the panel run. *See example.*

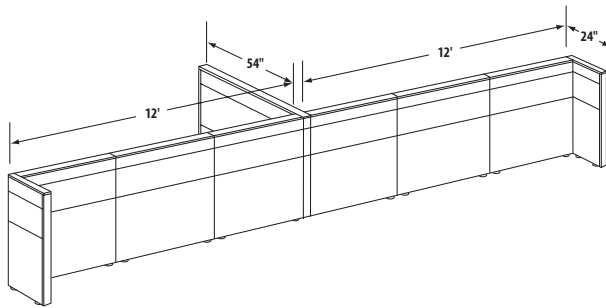

A longer run of Simon panels can be specified with the use of a 54" (minimum) opposing center panel. *See example.*

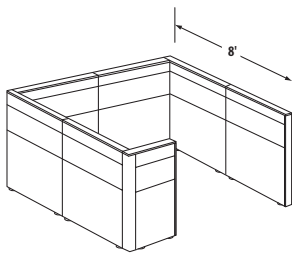

perpendicular panel runs –

A perpendicular run of Simon panels may not exceed 8' without an additional return panel. *See example.*

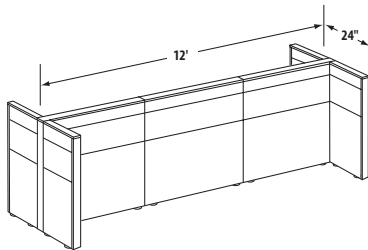

opposing returns –

A straight run of Simon panels can extend up to 12' when supported at both ends by 24" (minimum) opposing return panels. Return panel height must be within 48" of the panel run height. *See example.*

20" wide panel components

please specify:

- model number
- price

see also:

- panel specification (page 8)
- frames ordered separately (page 18)
- tiles ordered separately (page 19)

20" wide frames

Model #	Height (h)	Tile # total
S3520	35"	5
S4220	42"	6
S4920	49"	7
S5620	56"	8
S6320	63"	9
S7020	70"	10
S7720	77"	11
S8420	84"	12
S9120	91"	13
S9820	98"	14
S10520	105"	15

Model #	w	h	lbs	list price
S3520	20"	35"	12	\$183
S4220	20"	42"	14	208
S4920	20"	49"	15	231
S5620	20"	56"	17	247
S6320	20"	63"	19	285
S7020	20"	70"	21	335
S7720	20"	77"	22	368
S8420	20"	84"	24	386
S9120	20"	91"	25	433
S9820	20"	98"	27	509
S10520	20"	105"	29	549

20" wide tiles

for ordering separately

Model #	w	h	lbs	"E" Enamel	"F" Fabric	"A" Acoustic	"S" Acoustic+	"L" Laminate	"N" None	"R" Frosted	"C" Clear Plexi
T-0720_	20"	7"=1	2	\$34	\$42	\$54	\$63	\$46	N/C	\$200	\$163
T-1420_	20"	14"=2	3	46	65	90	103	65	N/C	313	236
T-2120_	20"	21"=3	5	62	80	118	133	80	N/C	452	316
T-2820_	20"	28"=4	5	71	103	147	172	126	N/C	574	400
T-3520_	20"	35"=5	7	84	125	193	215	155	N/C	-	-

2-sided tiles – specify inside only

note: when ordering tiles separately, model number is completed by adding the desired finish. example: T-3520E

* used in combination with acoustical pillow (see page 67)

specification examples:

unequal tile configuration

panel 63h x 20w panel	inside tile configuration 28" fabric tile 21" acoustic tile 14" fabric tile	outside tile configuration 35" enamel tile 28" enamel tile	price
S 6 3 2 0	4 F 3 A 2 F	5 E 4 E	\$726

equal tile configuration

panel 63h x 20w panel	inside tile configuration 28" fabric tile 21" acoustic tile 14" fabric tile	outside tile configuration equals inside tile configuration	price
S 6 3 2 0	4 F 3 A 2 F	D	\$857



24" wide panel components

please specify:

- model number
- price

see also:

- panel specification (page 8)
- frames ordered separately (page 18)
- tiles ordered separately (page 19)

24" wide frames

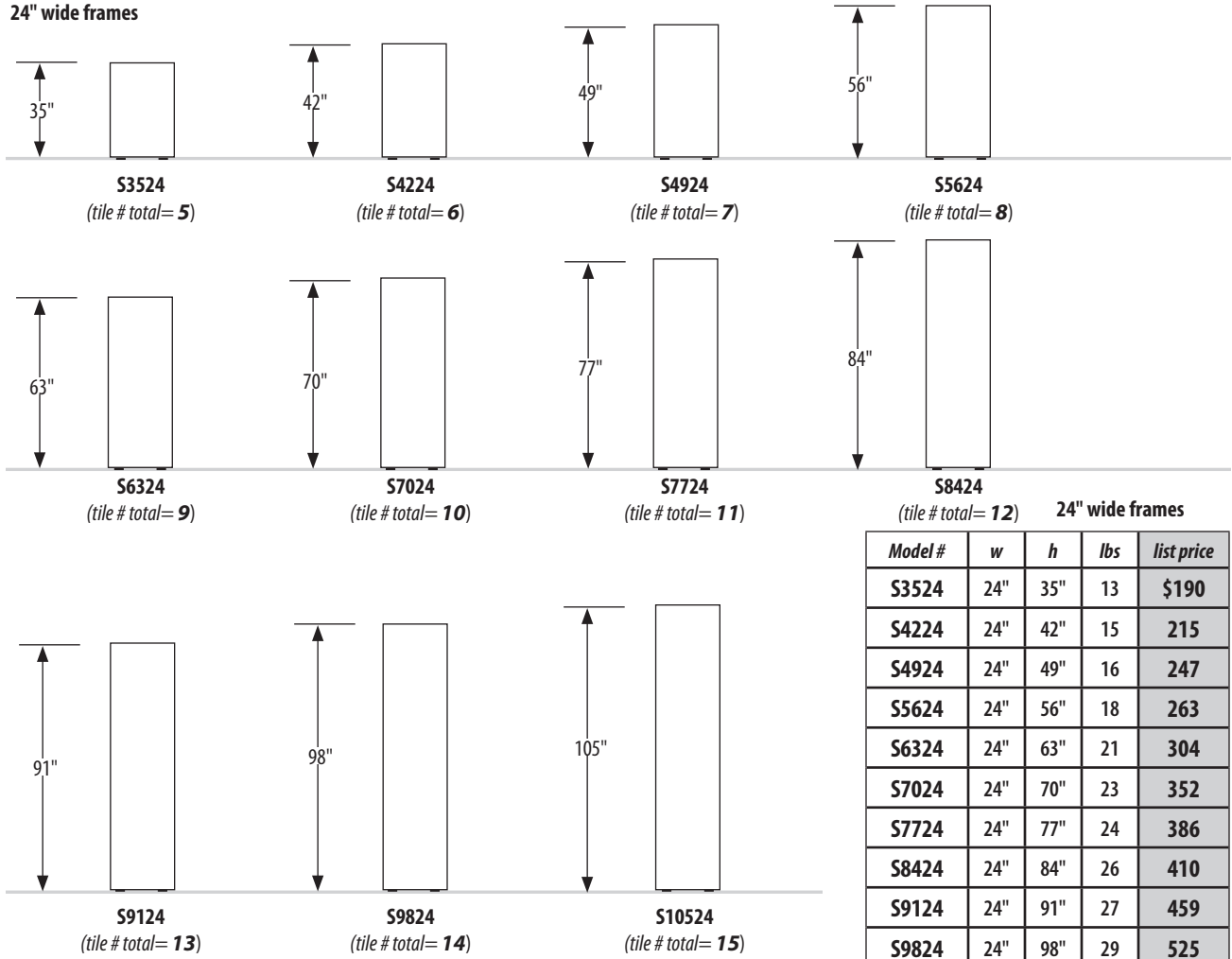

Model #	w	h	lbs	list price
S3524	24"	35"	13	\$190
S4224	24"	42"	15	215
S4924	24"	49"	16	247
S5624	24"	56"	18	263
S6324	24"	63"	21	304
S7024	24"	70"	23	352
S7724	24"	77"	24	386
S8424	24"	84"	26	410
S9124	24"	91"	27	459
S9824	24"	98"	29	525
S10524	24"	105"	30	568

24" wide tiles

for ordering separately



2-sided tiles – specify inside only

Model #	w	h	lbs	"E" Enamel	"F" Fabric	"A" Acoustic	"S" Acoustic+	"L" Laminate	"N" None	"R" Frosted	"C" Clear Plexi	"B" Storage Bin
T-0724_	24"	7"=1	2	\$35	\$46	\$62	\$65	\$46	N/C	\$217	\$182	-
T-1424_	24"	14"=2	4	48	69	96	107	69	N/C	349	254	430
T-2124_	24"	21"=3	6	65	87	126	142	87	N/C	500	363	-
T-2824_	24"	28"=4	7	76	111	161	182	130	N/C	662	452	-
T-3524_	24"	35"=5	9	94	138	208	231	163	N/C	-	-	-

note: when ordering tiles separately, model number is completed by adding the desired finish. **example:** T-3524E

* used in combination with acoustical pillow (see page 67)
† storage bin options available (see page 64)

specification examples:

unequal tile configuration

panel 63h x 24w panel	inside tile configuration 28" fabric tile 21" acoustic tile 14" fabric tile	outside tile configuration 35" enamel tile 28" enamel tile	price
S 6 3 2 4	4 F 3 A 2 F	5 E 4 E	\$780

equal tile configuration

panel 63h x 24w panel	inside tile configuration 28" fabric tile 21" acoustic tile 14" fabric tile	outside tile configuration equals inside tile configuration	price
S 6 3 2 4	4 F 3 A 2 F	D	\$916



30" wide panel components

please specify:

- model number
- price

see also:

- panel specification (page 8)
- frames ordered separately (page 18)
- tiles ordered separately (page 19)

Simon
frame and tile system

30" wide frames

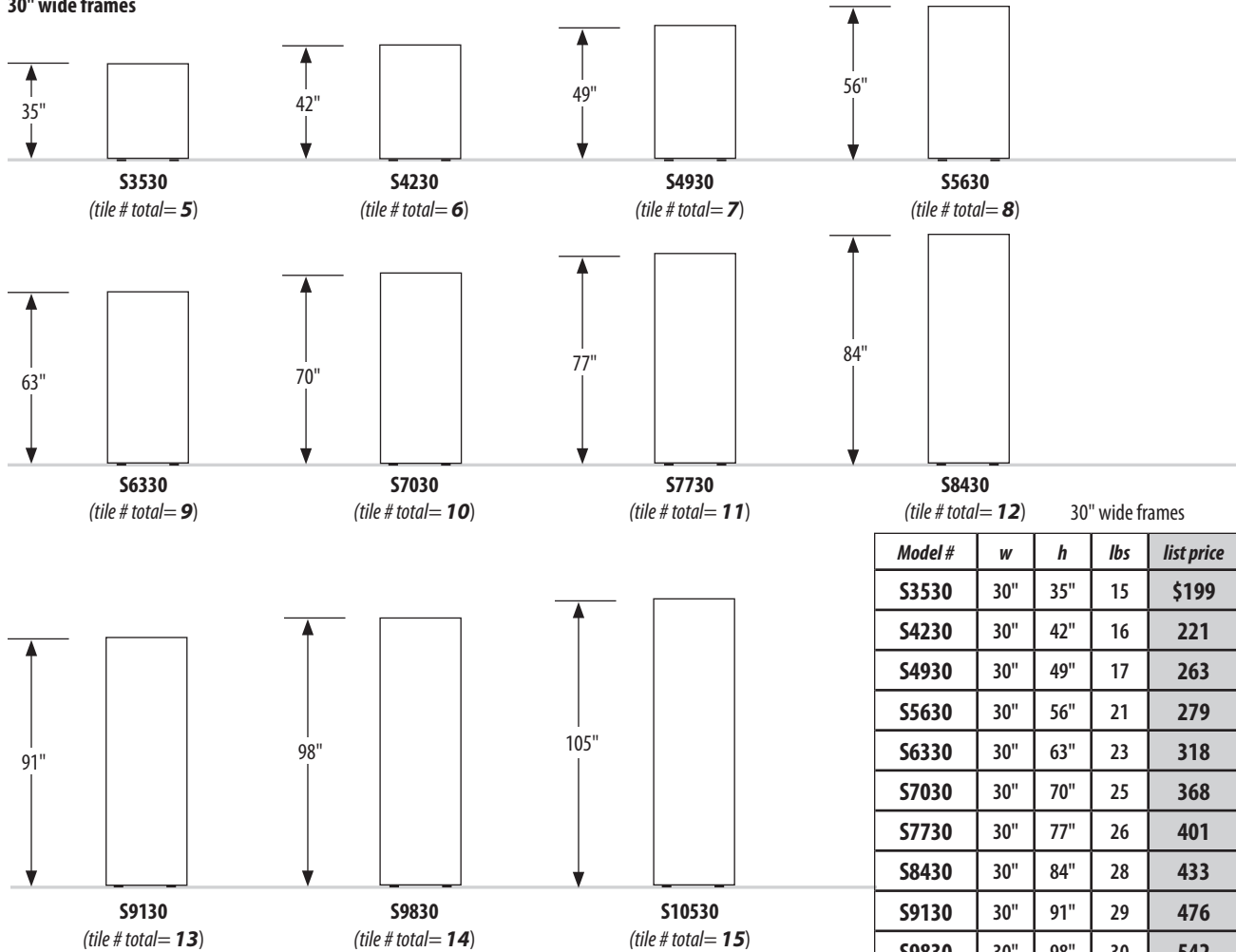

Model #	w	h	lbs	list price
S3530	30"	35"	15	\$199
S4230	30"	42"	16	221
S4930	30"	49"	17	263
S5630	30"	56"	21	279
S6330	30"	63"	23	318
S7030	30"	70"	25	368
S7730	30"	77"	26	401
S8430	30"	84"	28	433
S9130	30"	91"	29	476
S9830	30"	98"	30	542
S10530	30"	105"	32	584

30" wide tiles

2-sided tiles – specify inside only

for ordering separately



Model #	w	h	lbs	"E" Enamel	"F" Fabric	"A" Acoustic	"S" Acoustic+	"L" Laminate	"N" None	"R" Frosted	"C" Clear Plexi	"B" Storage Bin
T-0730_	30"	7"=1	2	\$37	\$47	\$66	\$70	\$47	N/C	\$270	\$217	-
T-1430_	30"	14"=2	5	56	72	109	119	72	N/C	444	327	478
T-2130_	30"	21"=3	7	71	96	145	160	96	N/C	627	436	-
T-2830_	30"	28"=4	9	87	118	183	206	139	N/C	791	501	-
T-3530_	30"	35"=5	11	107	147	240	267	176	N/C	-	-	-

note: when ordering tiles separately, model number is completed by adding the desired finish. **example:** T-3530E

* used in combination with acoustical pillow (see page 67)
† storage bin options available (see page 64)

specification examples:

unequal tile configuration

panel 63h x 24w panel	inside tile configuration 28" fabric tile 21" acoustic tile 14" fabric tile	outside tile configuration 35" enamel tile 28" enamel tile	price
S 6 3 3 0	4 F 3 A 2 F	5 E 4 E	\$847

equal tile configuration

panel 63h x 24w panel	inside tile configuration 28" fabric tile 21" acoustic tile 14" fabric tile	outside tile configuration equals inside tile configuration	price
S 6 3 3 0	4 F 3 A 2 F	D	\$988



36" wide panel components

please specify:

- model number
- price

see also:

- panel specification (page 8)
- frames ordered separately (page 18)
- tiles ordered separately (page 19)

36" wide frames

Model #	w	h	lbs	list price
S3536	36"	35"	16	\$215
S4236	36"	42"	17	240
S4936	36"	49"	19	279
S5636	36"	56"	23	305
S6336	36"	63"	25	334
S7036	36"	70"	27	386
S7736	36"	77"	28	433
S8436	36"	84"	30	466
S9136	36"	91"	31	509
S9836	36"	98"	32	575
S10536	36"	105"	34	615

36" wide tiles

for ordering separately



2-sided tiles – specify inside only

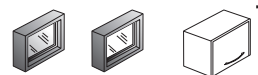

Model #	w	h	lbs	"E" Enamel	"F" Fabric	"A" Acoustic	"S" Acoustic+	"L" Laminate	"N" None	"R" Frosted	"C" Clear Plexi	"B" Storage Bin
T-0736_	36"	7"=1	3	\$40	\$64	\$78	\$84	\$64	N/C	\$323	\$272	-
T-1436_	36"	14"=2	6	62	91	134	150	96	N/C	522	363	\$541
T-2136_	36"	21"=3	8	80	125	183	203	125	N/C	741	501	-
T-2836_	36"	28"=4	11	97	152	229	258	191	N/C	941	609	-
T-3536_	36"	35"=5	14	118	197	305	340	209	N/C	-	-	-

note: when ordering tiles separately, model number is completed by adding the desired finish. **example:** T-3536E

* used in combination with acoustical pillow (see page 67)
† storage bin options available (see page 64)

specification examples:

unequal tile configuration

panel 63h x 24w panel	inside tile configuration 28" fabric tile 21" acoustic tile 14" fabric tile	outside tile configuration 35" enamel tile 28" enamel tile	price
S 6 3 3 6	4 F 3 A 2 F	5 E 4 E	\$975

equal tile configuration

panel 63h x 24w panel	inside tile configuration 28" fabric tile 21" acoustic tile 14" fabric tile	outside tile configuration equals inside tile configuration	price
S 6 3 3 6	4 F 3 A 2 F	D	\$1,186



42" wide panel components

please specify:

- model number
- price

see also:

- panel specification (page 8)
- frames ordered separately (page 18)
- tiles ordered separately (page 19)

42" wide frames

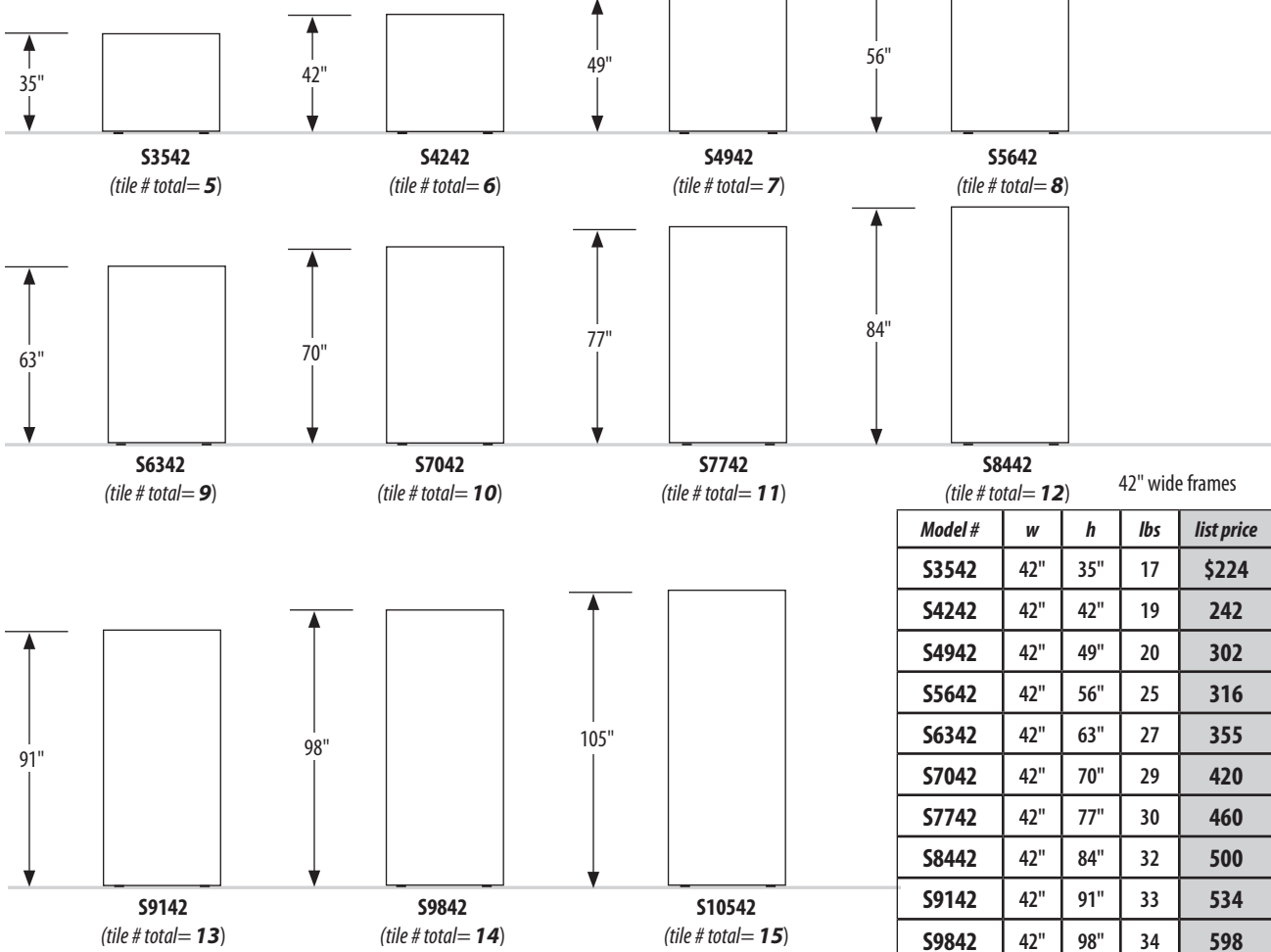

Model #	w	h	lbs	list price
S3542	42"	35"	17	\$224
S4242	42"	42"	19	242
S4942	42"	49"	20	302
S5642	42"	56"	25	316
S6342	42"	63"	27	355
S7042	42"	70"	29	420
S7742	42"	77"	30	460
S8442	42"	84"	32	500
S9142	42"	91"	33	534
S9842	42"	98"	34	598
S10542	42"	105"	36	641

42" wide tiles

for ordering separately



2-sided tiles – specify inside only



Model #	w	h	lbs	"E" Enamel	"F" Fabric	"A" Acoustic	"S" Acoustic+	"L" Laminate	"N" None	"R" Frosted	"C" Clear Plexi	"B" Storage Bin
T-0742_	42"	7"=1	4	\$49	\$74	\$97	\$107	\$74	N/C	\$366	\$282	-
T-1442_	42"	14"=2	7	72	112	158	175	112	N/C	603	427	\$597
T-2142_	42"	21"=3	10	94	150	217	241	150	N/C	853	573	-
T-2842_	42"	28"=4	13	115	187	260	290	203	N/C	1082	691	-
T-3542_	42"	35"=5	16	142	232	361	401	249	N/C	-	-	-

note: when ordering tiles separately, model number is completed by adding the desired finish. **example:** T-3542E

* used in combination with acoustical pillow (see page 67)
† storage bin options available (see page 64)

specification examples:

unequal tile configuration

panel 63h x 24w panel S 6 3 4 2	inside tile configuration 28" fabric tile 21" acoustic tile 14" fabric tile 4 F 3 A 2 F	outside tile configuration 35" enamel tile 28" enamel tile 5 E 4 E	price \$1,139
---	---	---	------------------------------------

equal tile configuration

panel 63h x 24w panel S 6 3 4 2	inside tile configuration 28" fabric tile 21" acoustic tile 14" fabric tile 4 F 3 A 2 F	outside tile configuration equals inside tile configuration D	price \$1,398
---	---	---	------------------------------------

price list #38 – simon frame and tile system



48" wide panel components

please specify:

- model number
- price

see also:

- panel specification (page 8)
- frames ordered separately (page 18)
- tiles ordered separately (page 19)

48" wide frames

Model #	w	h	lbs	list price
S3548	48"	35"	19	\$247
S4248	48"	42"	20	271
S4948	48"	49"	21	325
S5648	48"	56"	27	342
S6348	48"	63"	29	389
S7048	48"	70"	30	450
S7748	48"	77"	32	508
S8448	48"	84"	33	540
S9148	48"	91"	35	575
S9848	48"	98"	36	660
S10548	48"	105"	37	717

48" wide tiles

for ordering separately



2-sided tiles – specify inside only

Model #	w	h	lbs	"E" Enamel	"F" Fabric	"A" Acoustic	"S" Acoustic+	"L" Laminate	"N" None	"R" Frosted	"C" Clear Plexi	"B" Storage Bin
T-0748_	48"	7"=1	4	\$54	\$78	\$107	\$115	\$78	N/C	\$410	\$410	-
T-1448_	48"	14"=2	7	78	116	172	188	116	N/C	636	473	\$652
T-2148_	48"	21"=3	11	103	157	234	262	157	N/C	897	636	-
T-2848_	48"	28"=4	15	125	203	299	333	217	N/C	1222	773	-
T-3548_	48"	35"=5	19	151	245	392	437	269	N/C	-	-	-

note: when ordering tiles separately, model number is completed by adding the desired finish. **example:** T-3548E

* used in combination with acoustical pillow (see page 67)
† storage bin options available (see page 64)

specification examples:

unequal tile configuration

panel 63h x 24w panel	inside tile configuration 28" fabric tile 21" acoustic tile 14" fabric tile	outside tile configuration 35" enamel tile 28" enamel tile	price
S 6 3 4 8	4 F 3 A 2 F	5 E 4 E	\$1,218

equal tile configuration

panel 63h x 24w panel	inside tile configuration 28" fabric tile 21" acoustic tile 14" fabric tile	outside tile configuration equals inside tile configuration	price
S 6 3 4 8	4 F 3 A 2 F	D	\$1,495



54" wide panel components

please specify:

- model number
- price

see also:

- panel specification (page 8)
- frames ordered separately (page 18)
- tiles ordered separately (page 19)

54" wide frames

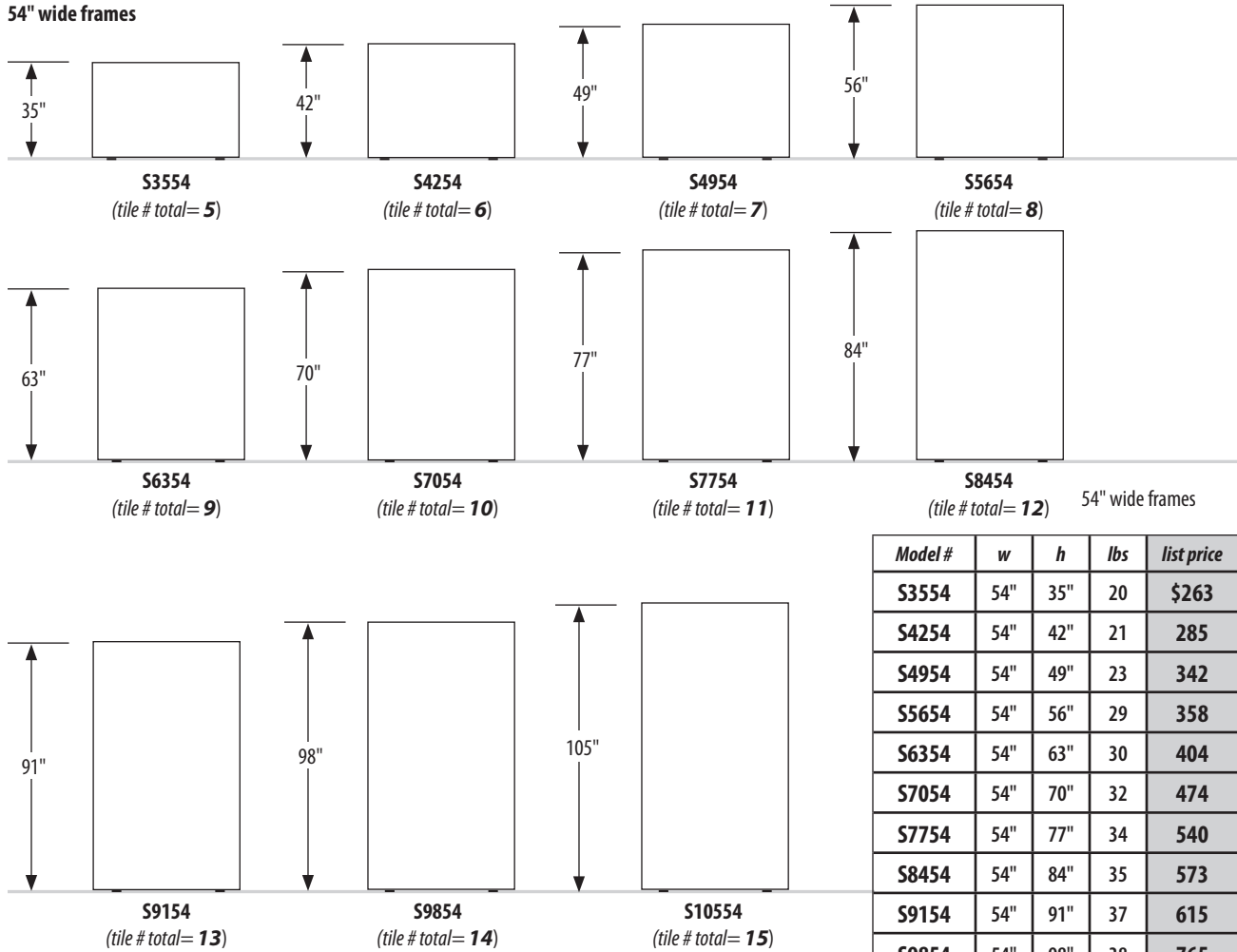

Model #	w	h	lbs	list price
S3554	54"	35"	20	\$263
S4254	54"	42"	21	285
S4954	54"	49"	23	342
S5654	54"	56"	29	358
S6354	54"	63"	30	404
S7054	54"	70"	32	474
S7754	54"	77"	34	540
S8454	54"	84"	35	573
S9154	54"	91"	37	615
S9854	54"	98"	38	765
S10554	54"	105"	39	825

54" wide tiles

for ordering separately

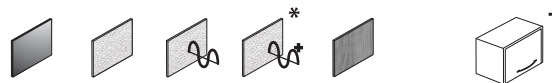

Model #	w	h	lbs	"E" Enamel	"F" Fabric	"A" Acoustic	"S" Acoustic+	"L" Laminate	"N" None	"B" Storage Bin
T-0754_	54"	7"=1	4	\$58	\$81	\$112	\$122	\$81	N/C	-
T-1454_	54"	14"=2	8	83	122	185	206	122	N/C	\$717
T-2154_	54"	21"=3	13	111	163	248	279	163	N/C	-
T-2854_	54"	28"=4	17	134	208	318	359	250	N/C	-
T-3554_	54"	35"=5	21	167	260	424	462	318	N/C	-

note: when ordering tiles separately, model number is completed by adding the desired finish. **example:** T-3554E

* used in combination with acoustical pillow (see page 67)
† storage bin options available (see page 64)

specification examples:

unequal tile configuration

panel 63h x 24w panel S 6 3 5 4	inside tile configuration 28" fabric tile 21" acoustic tile 14" fabric tile 4 F 3 A 2 F	outside tile configuration 35" enamel tile 28" enamel tile 5 E 4 E	price \$1,283
---	---	---	------------------------------------

equal tile configuration

panel 63h x 24w panel S 6 3 5 4	inside tile configuration 28" fabric tile 21" acoustic tile 14" fabric tile 4 F 3 A 2 F	outside tile configuration equals inside tile configuration D	price \$1,560
---	---	---	------------------------------------



ordering frames separately

Simon panel frames can be ordered individually. When ordering frames you must indicate crossmember locations. Each crossmember corresponds to a tile "grout line." Use the guidelines below to determine locations.

step 1 – determine crossmember locations

example: 63" high x 24" wide panel. Starting from the bottom of the panel, list the smallest tile number from both sides, then the sum of the 2nd, then the sum of the 3rd, etc.

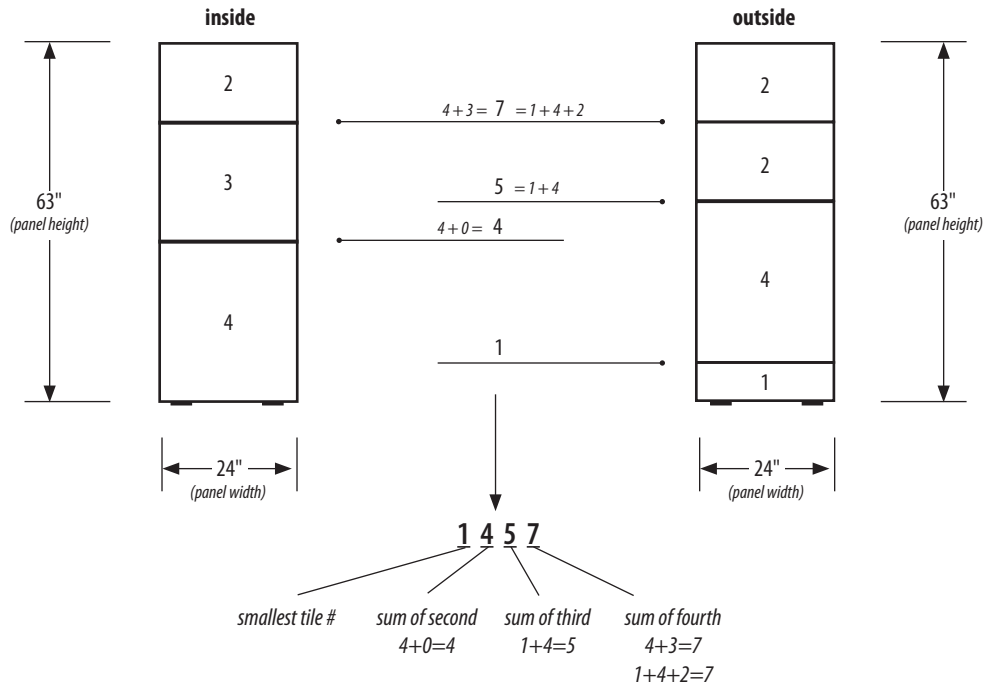

step 2 – determine model number and pricing

Use the frame pricing and model number (see pp 11-17) and add the crossmember locations as a suffix to the frame number.

example: 63" high x 24" wide panel:

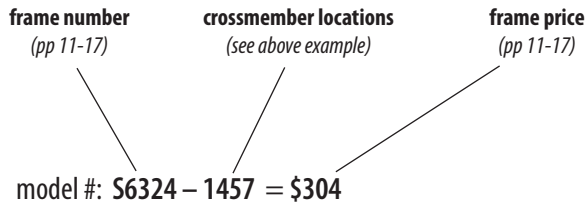

Note: if additional crossmembers are required for field changes to tile size or locations, order using the following chart:

Model #	w (panel width)	list price
FCM-20	20"	\$58
FCM-24	24"	64
FCM-30	30"	68
FCM-36	36"	71
FCM-42	42"	75
FCM-48	48"	78
FCM-54	54"	82

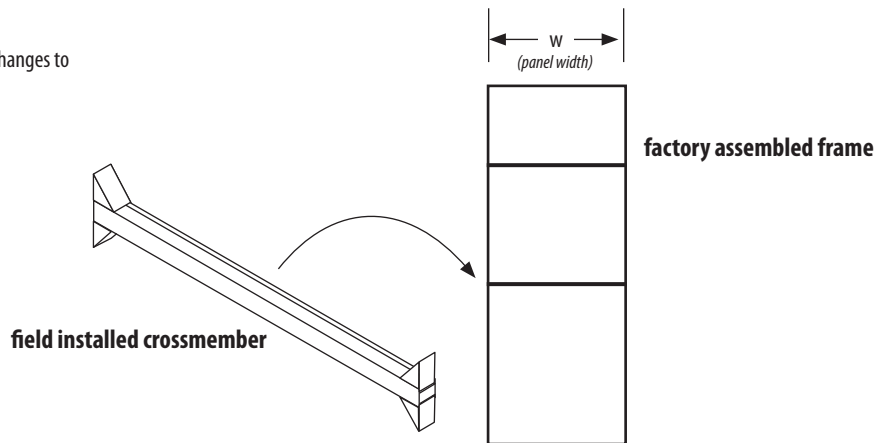

ordering tiles separately

Simon tiles can be ordered individually. When ordering tiles you must indicate size, finish and knock-out locations (if needed). Use the guidelines below.

step 1 – determine tile dimensions

example: 63" high x 24" wide panel: inside/middle tile with bottom knock-outs

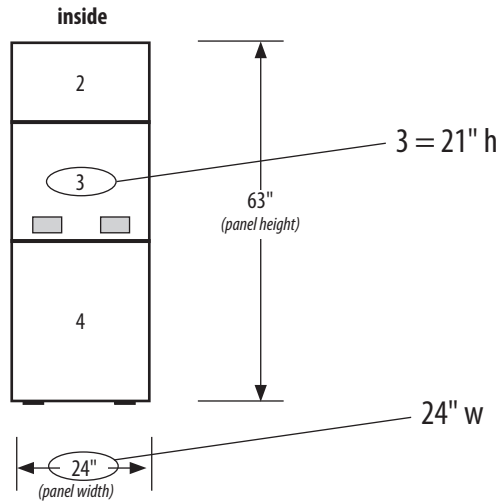

step 2 – determine tile type

Select tiles from those listed on pp 6-7.

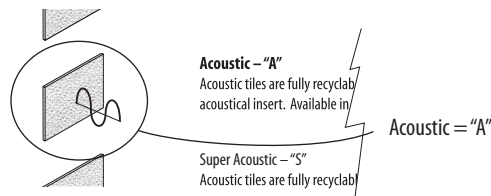

step 3 – add knock-outs (if needed)

If power/data knock-outs are required, select a configuration from those listed on page 31.

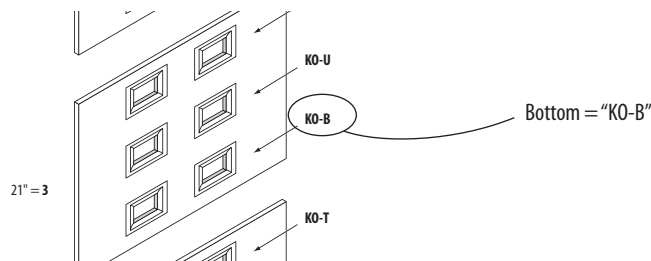

step 4 – determine model number and pricing

Use the tile model number (see pp 11-17) and add the type and knock-outs (if needed) as a suffix to complete the model number.

example: 63" high x 24" wide panel: inside/middle tile with bottom knock-outs

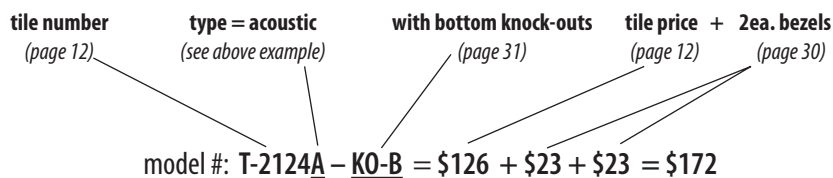

please specify:
• coating color

top caps

Simon top caps are standard with 22GA cold-rolled steel and enamel finish per specification. Top caps fasten to the top side of the internal frame structure with the provided steel bolts. Contact us for a list of available colors. Simon top caps are 3-7/8" wide x 5/8" high x specified length (see below):

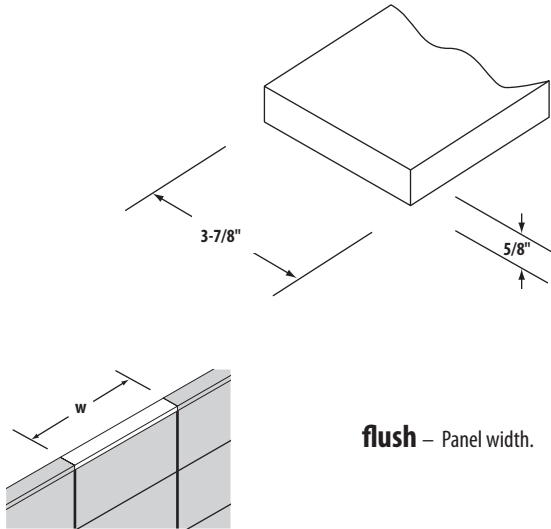

Model #	w	lbs	list price
TC-20	20"	2	\$17
TC-24	24"	2	23
TC-30	30"	2	25
TC-36	36"	2	28
TC-42	42"	3	30
TC-48	48"	3	36
TC-54	54"	3	38

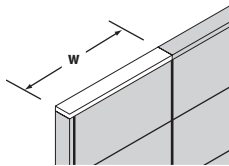

Model #	w	lbs	list price
TC-20-S	20-15/16"	2	\$17
TC-24-S	24-15/16"	2	23
TC-30-S	30-15/16"	2	25
TC-36-S	36-15/16"	2	28
TC-42-S	42-15/16"	3	30
TC-48-S	48-15/16"	3	36
TC-54-S	54-15/16"	3	38

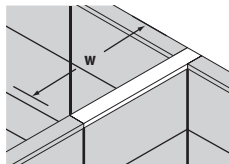

Model #	w	lbs	list price
TC-20-C	23-15/16"	2	\$17
TC-24-C	27-15/16"	2	23
TC-30-C	33-15/16"	2	25
TC-36-C	39-15/16"	2	28
TC-42-C	45-15/16"	3	30
TC-48-C	51-15/16"	3	36
TC-54-C	57-15/16"	3	38

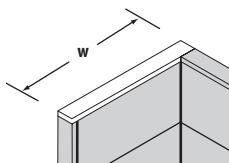

Model #	w	lbs	list price
TC-20-SC	24-7/8"	2	\$17
TC-24-SC	28-7/8"	2	23
TC-30-SC	34-7/8"	2	25
TC-36-SC	40-7/8"	2	28
TC-42-SC	46-7/8"	3	30
TC-48-SC	52-7/8"	3	36
TC-54-SC	58-7/8"	3	38

connector – Panel width + 3-15/16". For use on a panel that ends an inline run of panels at a 2-, 3- or 4-way connector (3-way shown).
note: for 135° connection, add "135" as a suffix to model #.

connector + single overhang – Panel width + 4-7/8". For use on a single panel at a 2-, 3- or 4-way connector (2-way shown).
note: for 135° connection, add "135" as a suffix to model #.



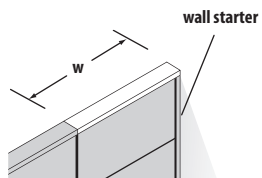

wall start – Panel width + 13/16". For use on a panel that begins a run of panels from a wall.

Model #	w	lbs	list price
TC-20-WS	20-13/16"	2	\$17
TC-24-WS	24-13/16"	2	23
TC-30-WS	30-13/16"	2	25
TC-36-WS	36-13/16"	2	28
TC-42-WS	42-13/16"	3	30
TC-48-WS	48-13/16"	3	36
TC-54-WS	54-13/16"	3	38

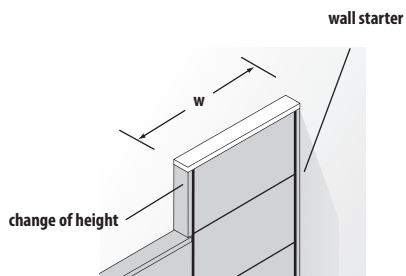

single overhang + wall start – Panel width + 1-3/4". For use on a single panel that does not connect to any adjacent panels or connectors of the same height.

Model #	w	lbs	list price
TC-20-SWS	21-3/4"	2	\$17
TC-24-SWS	25-3/4"	2	23
TC-30-SWS	31-3/4"	2	24
TC-36-SWS	37-3/4"	2	28
TC-42-SWS	43-3/4"	3	30
TC-48-SWS	49-3/4"	3	36
TC-54-SWS	55-3/4"	3	38

end caps

Simon end caps are standard with 22GA cold-rolled steel and enamel finish per specification. End caps fasten to the internal frame structure with the provided wedge block and bolt assembly. For a list of available enamel colors, please refer to *Enamel Selection Guide*.

Simon end caps are 3-7/8" wide x 3/4" deep x specified height (*see below*):

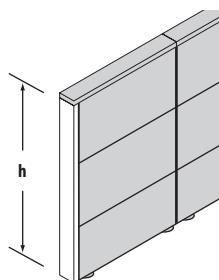
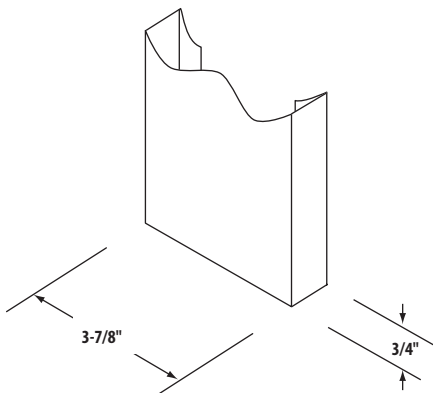

end cap – Panel height. For use on a panel with no adjacent panels or connectors.

Model #	h	lbs	list price
EC-35	35"	3	\$48
EC-42	42"	4	50
EC-49	49"	4	55
EC-56	56"	5	59
EC-63	63"	5	64
EC-70	70"	6	66
EC-77	77"	6	74
EC-84	84"	7	85
EC-91	91"	8	99
EC-98	98"	9	112
EC-105	105"	9	122



please specify:

- coating color
- fabric (optional)

see also:

- change of height connectors (page 24)

2-way connector – Connects two Simon panels of equal height at a 90° angle. Coating finished.

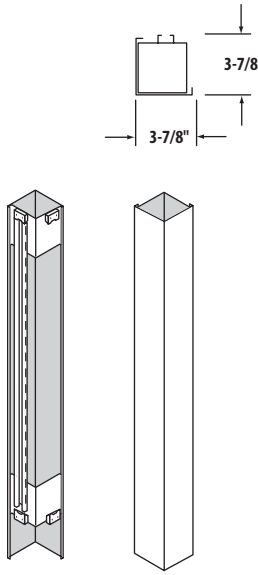

Model #	h	lbs	list price
2WC-35	35"	10	\$161
2WC-42	42"	12	177
2WC-49	49"	14	192
2WC-56	56"	16	225
2WC-63	63"	18	246
2WC-70	70"	20	271
2WC-77	77"	22	286
2WC-84	84"	24	317
2WC-91	91"	26	339
2WC-98	98"	28	370
2WC-105	105"	30	424

3-way connector – Connects three Simon panels of equal height at two 90° angles. Coating finished.

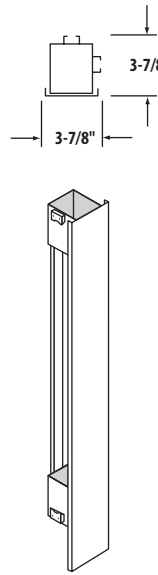

Model #	h	lbs	list price
3WC-35	35"	11	\$186
3WC-42	42"	13	201
3WC-49	49"	15	216
3WC-56	56"	18	254
3WC-63	63"	20	271
3WC-70	70"	22	294
3WC-77	77"	24	310
3WC-84	84"	26	339
3WC-91	91"	29	362
3WC-98	98"	31	402
3WC-105	105"	33	446

4-way connector – Connects four Simon panels of equal height at four 90° angles. Coating finished.

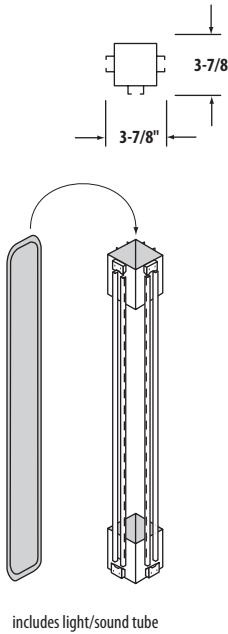

Model #	h	lbs	list price
4WC-35	35"	11	\$148
4WC-42	42"	13	161
4WC-49	49"	15	177
4WC-56	56"	18	209
4WC-63	63"	20	223
4WC-70	70"	22	247
4WC-77	77"	24	271
4WC-84	84"	26	301
4WC-91	91"	29	324
4WC-98	98"	31	356
4WC-105	105"	33	408



draw rod – Connects Simon panels to other Simon panels and connectors. Black finish.



Model #	h	lbs	list price
C-35	35"	1	\$55
C-42	42"	1	55
C-49	49"	2	55
C-56	56"	2	55
C-63	63"	2	55
C-70	70"	2	59
C-77	77"	3	59
C-84	84"	3	59
C-91	91"	3	63
C-98	98"	3	63
C-105	105"	3	63

in-line spacer – In-line spacer that connects two Simon panels of equal height. Coating finished.

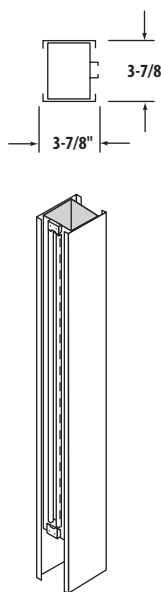

Model #	h	lbs	list price
IL-35	35"	10	\$186
IL-42	42"	12	201
IL-49	49"	14	216
IL-56	56"	16	254
IL-63	63"	18	271
IL-70	70"	20	294
IL-77	77"	22	310
IL-84	84"	24	339
IL-91	91"	26	362
IL-98	98"	28	402
IL-105	105"	30	447

135° 2-way connector –

Connects two Simon panels of equal height at a 135° angle. Coating finished.

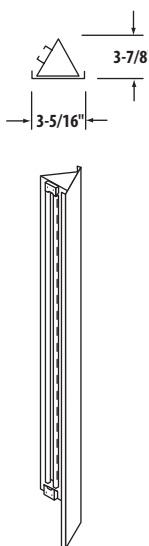

Model #	h	lbs	list price
135-2W-35	35"	10	\$370
135-2W-42	42"	12	402
135-2W-49	49"	14	433
135-2W-56	56"	16	510
135-2W-63	63"	18	542
135-2W-70	70"	20	586
135-2W-77	77"	22	617
135-2W-84	84"	24	679
135-2W-91	91"	26	727
135-2W-98	98"	28	803
135-2W-105	105"	30	896

120° 3-way connector –

Connects three Simon panels of equal height at a 120° angle. Coating finished.

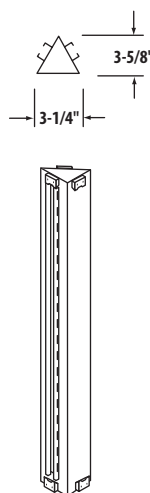

Model #	h	lbs	list price
120-3W-35	35"	10	\$370
120-3W-42	42"	12	402
120-3W-49	49"	14	433
120-3W-56	56"	16	510
120-3W-63	63"	18	542
120-3W-70	70"	20	586
120-3W-77	77"	22	617
120-3W-84	84"	24	679
120-3W-91	91"	26	726
120-3W-98	98"	28	803
120-3W-105	105"	30	896

change of height connectors

please specify:

- model number
- coating color
- sketch

2-way change of height – Connects two Simon panels of unequal height at a 90° angle. Coating finished 22GA steel.

note: model number is completed by indicating the change of height and providing sketch.

example: 2W-63/COH21 (63-42=21)

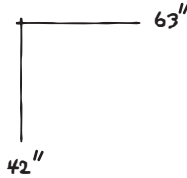
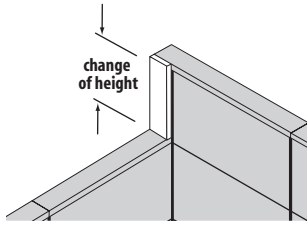

3-way change of height – Connects three Simon panels of unequal height at two 90° angles. Coating finished 22GA steel.

note: model number is completed by indicating the change of height and providing sketch.

example: 3W-70/COH14 (70-56=14)

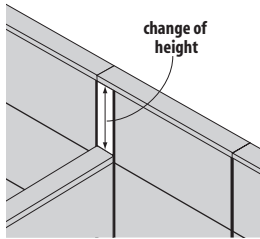

4-way change of height – Connects four Simon panels of unequal height at four 90° angles. Coating finished 22GA steel.

note: model number is completed by indicating the change of height and providing sketch.

example: 4W-42/COH7 (42-35=7)

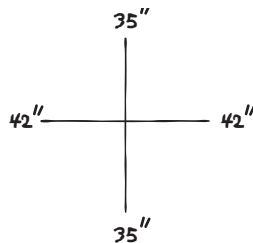
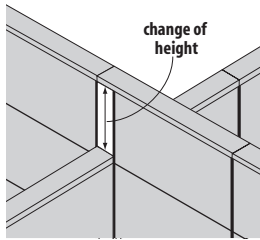

Inline change of height – Connects two Simon panels of unequal height inline. Coating finished 22GA steel.

note: please provide sketch. example: COHIL-14 (63-49)

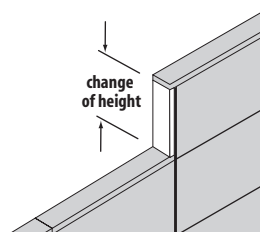

Model #	h	lbs	list price
2W-42/COH_	42"	13	\$286
2W-49/COH_	49"	15	301
2W-56/COH_	56"	17	332
2W-63/COH_	63"	19	349
2W-70/COH_	70"	21	362
2W-77/COH_	77"	23	377
2W-84/COH_	84"	25	418
2W-91/COH_	91"	27	433
2W-98/COH_	98"	29	477
2W-105/COH_	105"	31	526

Model #	h	lbs	list price
3W-42/COH_	42"	14	\$310
3W-49/COH_	49"	16	324
3W-56/COH_	56"	19	356
3W-63/COH_	63"	21	370
3W-70/COH_	70"	23	387
3W-77/COH_	77"	25	408
3W-84/COH_	84"	27	439
3W-91/COH_	91"	30	456
3W-98/COH_	98"	32	487
3W-105/COH_	105"	34	532

Model #	h	lbs	list price
4W-42/COH_	42"	14	\$370
4W-49/COH_	49"	16	391
4W-56/COH_	56"	19	424
4W-63/COH_	63"	21	439
4W-70/COH_	70"	23	456
4W-77/COH_	77"	25	471
4W-84/COH_	84"	27	502
4W-91/COH_	91"	30	518
4W-98/COH_	98"	32	564
4W-105/COH_	105"	34	603

Model #	h	lbs	list price
EC-7-COH	7"	1	\$84
EC-14-COH	14"	1	84
EC-21-COH	21"	2	86
EC-28-COH	28"	2	92
EC-35-COH	35"	2	92
EC-42-COH	42"	3	101
EC-49-COH	49"	3	101
EC-56-COH	56"	3	105



please specify:

- model number
- coating color

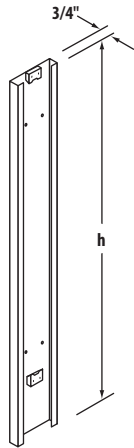

wall starter – Connects a Simon panel to a wall. Coating finished.

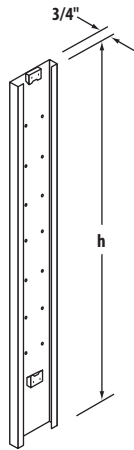

universal connector – Connects to a Simon panel at any point along a panel run.

Screws fit through tile "grout line" and into frame. Tiles must be affixed to frame before installing universal connector. Coating finished.

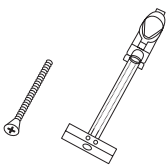

wall start fasteners (toggles) – mount wall starter to standard dry-wall.

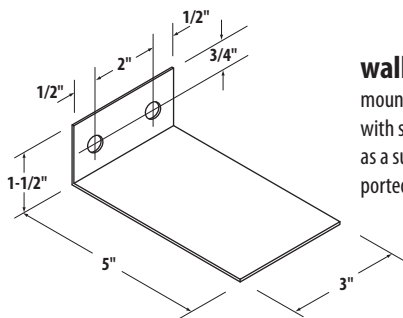

wall bracket – mounts to top, bottom or crossmember of frame with sheet metal screws - then to wall. Intended as a supplemental field support for long or unsupported panel runs. Adjustable 0-3" panel to wall.

Model #	h	lbs	list price
WS-35	35"	3	\$66
WS-42	42"	4	70
WS-49	49"	4	71
WS-56	56"	5	78
WS-63	63"	5	78
WS-70	70"	6	84
WS-77	77"	6	91
WS-84	84"	7	92
WS-91	91"	8	96
WS-98	98"	9	106
WS-105	105"	9	116

Model #	h	lbs	list price
UC-35	35"	3	\$98
UC-42	42"	4	101
UC-49	49"	4	105
UC-56	56"	5	107
UC-63	63"	5	111
UC-70	70"	6	113
UC-77	77"	6	120
UC-84	84"	7	122
UC-91	91"	8	127
UC-98	98"	9	137
UC-105	105"	9	148

Model #	lbs	list price
WFK-1	.05	\$8

Model #	lbs	list price
WB-1	.10	\$43



please specify:

- model number
- coating color (frame)
- laminate (door)
- right or left hand

see also:

- *Laminate Selection Guide*

Simon doors

Simon doors are factory assembled and ready to install. Fully laminated door comes standard with lock and may be ordered right or left hand.

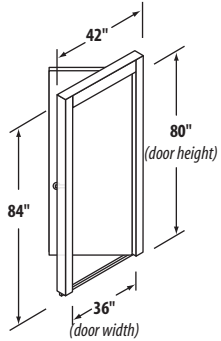

84" high door unit

"R" = right hand (shown)
 "L" = left hand (swings opposite)

left hand right hand

Model #	Model #	w	h	lbs	list price
SD-8442L	SD-8442R	42"	84"	93	\$4555

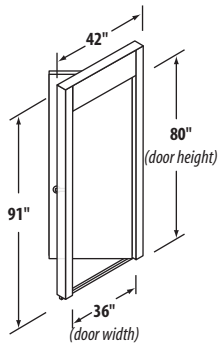

91" high door unit

"R" = right hand (shown)
 "L" = left hand (swings opposite)

left hand right hand

Model #	Model #	w	h	lbs	list price
SD-9142L	SD-9142R	42"	91"	101	\$4710

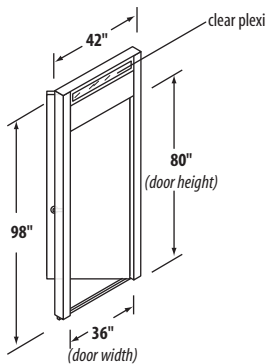

98" high door unit

"R" = right hand (shown)
 "L" = left hand (swings opposite)

left hand right hand

Model #	Model #	w	h	lbs	list price
SD-9842L	SD-9842R	42"	98"	109	\$4863

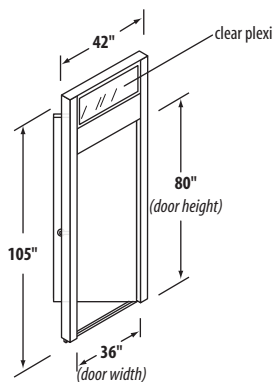

105" high door unit

"R" = right hand (shown)
 "L" = left hand (swings opposite)

left hand right hand

Model #	Model #	w	h	lbs	list price
SD-10542L	SD-10542R	42"	105"	117	\$5018



please specify:

- model number
- coating color

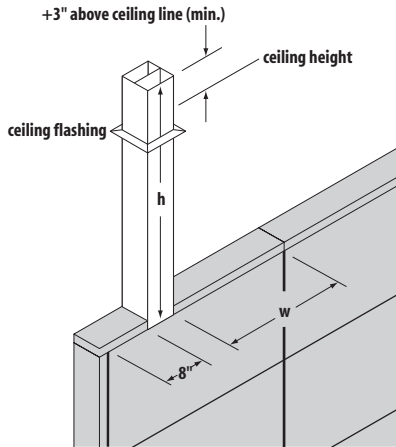

power tower –

integrates beautifully into top of panel at almost any location. Dual chamber – high capacity. Simultaneous capacity: 6 electrical feeds and 180 voice/data cables.

Standard with height adjustable ceiling flashing.

To determine power tower height measure the distance between top of panel and ceiling. Allow at least 3" extra length.

Model #	h	lbs	list price
PT-24	24"	6	\$254
PT-30	30"	7	294
PT-36	36"	9	332
PT-42	42"	10	370
PT-48	48"	12	408
PT-54	54"	13	447
PT-60	60"	15	487
PT-66	66"	17	530

power tower top caps (2 pieces)

Split at the power tower 8" from either end of the panel. Power towers attach to any panel except over storage bins and glass.

enamel power tower top caps

Model #	w	lbs	list price
TC-20PT	8-1/8 & 8"	2	\$35
TC-24PT	12-1/8 & 8"	2	36
TC-30PT	18-1/8 & 8"	2	38
TC-36PT	24-1/8 & 8"	2	41
TC-42PT	30-1/8 & 8"	3	43
TC-48PT	36-1/8 & 8"	3	48
TC-54PT	42-1/8 & 8"	3	57

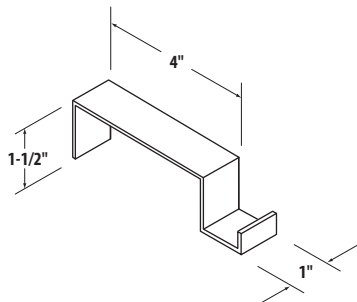

steel coat hook –

Felt lined. Fits snugly over any Simon Panel.

Model #	lbs	list price
CH-1	.10	\$148 (pkg of 4)



Simon electrical system

The Simon electrical system is a 20 amp system allowing the use of 4 circuits with 4 line conductors, 2 neutrals and 2 grounds. Under NEC recommendations, 13 receptacles may be used per circuit, with a total of 52 available receptacles if all circuits are used, per single power entry. The Simon electrical system can be wired in both single phase 208/120V, and three phase 240/120V configurations.



At the heart of the Simon electrical system is the unique six point contact terminal. This quad terminal is rated at over 50 amps, offering built in overload insurance. Its unique design distributes the power, reducing the number of internal connection points. The six points of contact provide a stable connection, eliminating rocking.

All connections are positive locking, assured by keyed terminal housings. The patented slide mount is easily installed on site after frame assembly. Receptacles simply snap in with a positive locking tab feature that assures positive contact to the power blocks. Furthermore, harnesses and receptacles are installed without tools.

- UL listings 1286 and 183
- CSA Standard C22.2 No. 203
- 8-wire 20-amp 4-circuit system

specifying Simon electrical – step by step

- step 1** – determine circuit configuration (see diagrams below)
 - 3+1 configuration – 3 utility circuits and 1 isolated/dedicated circuit
 - 2+2 configuration – 2 utility circuits and 2 isolated circuit
 - (for other circuit configurations, please contact factory)
- step 2** – determine location, quantity and circuit numbers of duplex receptacles
- step 3** – determine appropriate use of isolated and separate neutral circuits
- step 4** – determine location(s) and type of power feed
- step 5** – specify appropriate electrical components (see diagrams below)

four circuit, 3+1 receptacle configuration – 3+1 configuration provides three utility circuits and one isolated circuit for more sensitive equipment. Note: with this configuration, circuit 2 cannot be used with single-phase building electrical supply.

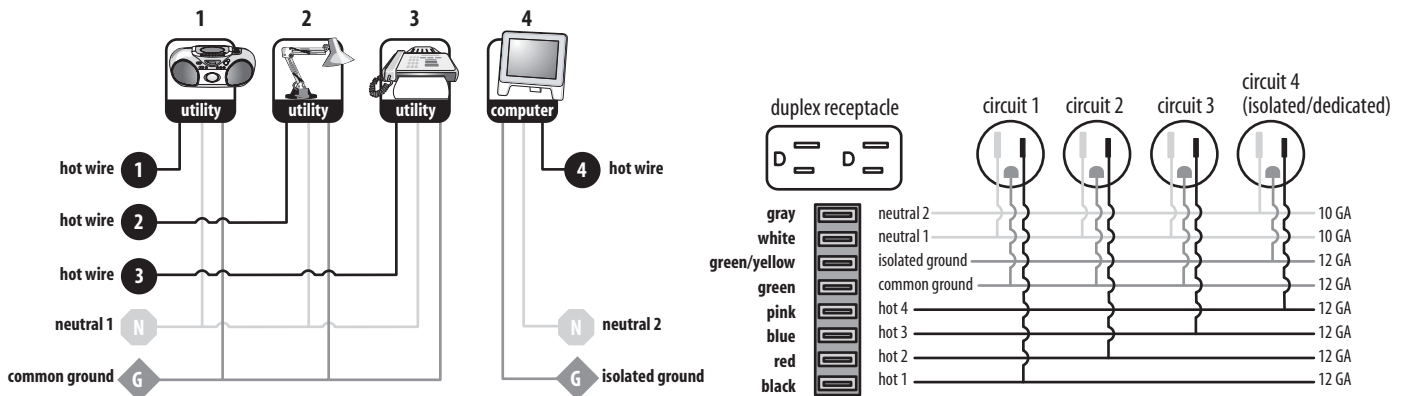

four circuit, 2+2 receptacle configuration – 2+2 configuration provides two utility circuits and two isolated circuit for heavy computer usage.

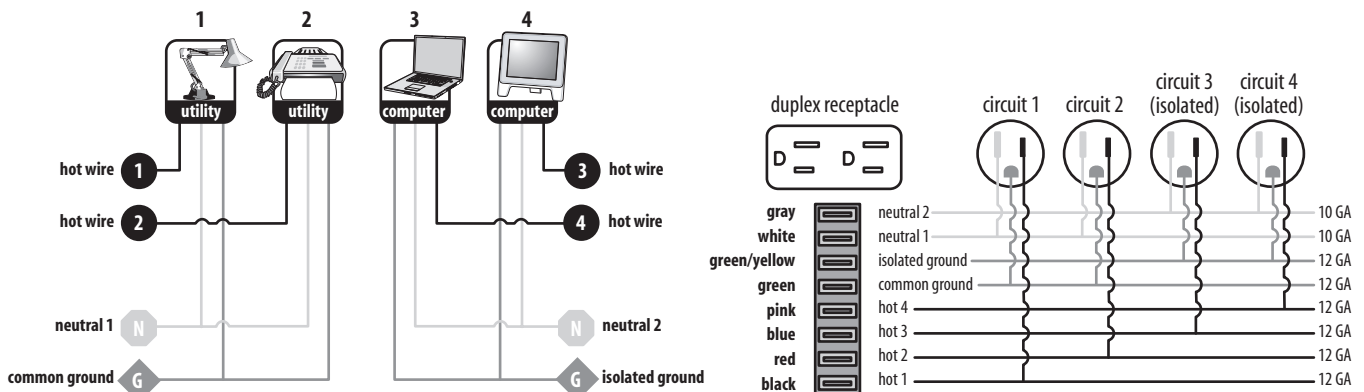

please specify:

- model number
- circuit configuration

M = male connection
F = female connection

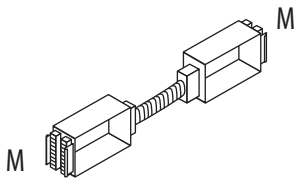

junction blocks –
double sided. Attaches to Simon frames and allows for placement of duplex receptacle(s).

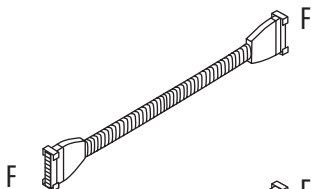

jumper cable –
cable with double female ends for connecting junction blocks.

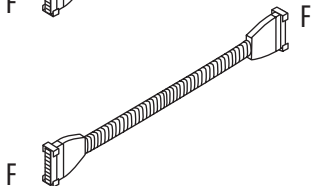

20" frame jumper cable –
cable with double female ends for connecting junction blocks.

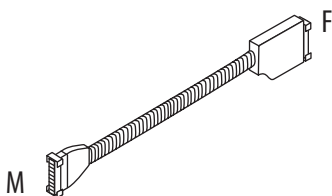

pass-thru cable –
free-floating cable that passes power thru a panel that does not contain duplex receptacles.



15 AMP duplex receptacle –
3+1 configuration = 3 utility circuits and 1 isolated/dedicated (computer) circuit.
2+2 configuration = 2 utility circuits and 2 isolated circuits. Snaps into junction block. Standard in textured black.

power feeds

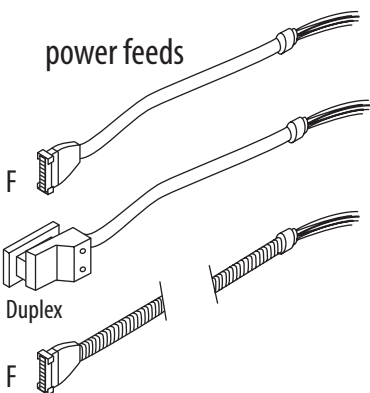

base/end power feed –
liquid tight cable that connects power from building floor or wall into the Simon electrical system.

ceiling power feed –
field adjustable cable that connects power from ceiling area into the Simon electrical system. via our PowerTower (see page 27)

model #	l	w	lbs	list price
EB-24	7"	20 & 24"	0.5	\$99
EB-30	12"	30"	0.75	123
EB-36	16"	36"	1	148
EB-42	22"	42"	1	155
EB-48	28"	48"	1.25	167
EB-54	40"	54"	1.25	178

model #	connection type	l	lbs	list price
EJ-20	in line	20"	1	\$109
EJ-24	2, 3, or way connector	24"	1	112
EJ-48	change of level	48"	2	145

model #	connection type	l	lbs	list price
EJ-16	in line 20"w to 20"w	16"	1	\$104
EJ-18	in line 20"w to any other width	18"	1	107
EJ-20	connector + 20"w to 20"w	20"	1	109
EJ-22	connector + 20"w to any other width	22"	1	110

model #	l	w	lbs	list price
EPT-24	24"	24"	1.5	\$113
EPT-30	30"	30"	1.5	117
EPT-36	36"	36"	2	122
EPT-42	42"	42"	2	126
EPT-48	48"	48"	2.5	139
EPT-54	54"	54"	2.5	151
EPT-60	60"	2ea. 30"	3	155
EPT-66	66"	30 + 36 "	3	163
EPT-72	72"	2ea. 36"	3.5	172

model #	circuit description	load	lbs	list price
E0-1	1 - utility	15 AMP	0.25	\$33
E0-2	2 - utility	15 AMP	0.25	33
E0-1/20	1 -20 AMP utility	20 AMP	0.25	33
E0-3	3 - utility	15 AMP	0.25	33
E0-3/2+2	3 - 2 + 2	15 AMP	0.25	33
E0-4	4 - ISO/dedicated	15 AMP	0.25	33

model #	description	l	lbs	list price
BPF-6	connects to junction block	6'	4	\$215
BPF-6-DRO	connects into duplex receptacle	6'	4	231

model #	l	lbs	list price
CPF-12	12'	6	\$278
CPF-18	18'	9	304



please specify:
• model number

see also:
• electrical overview (page 28)
• tile knock-out guide (next page)

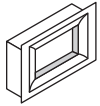

tile bezel – snaps into tile knock-out. Bezel accommodates electrical duplex receptacles and data ports. Standard in textured black plastic.

Model #	lbs	list price
B-1	0.05	\$23

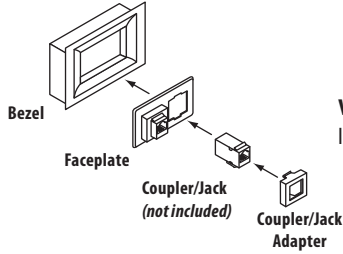

voice and data faceplate kit – snaps into tile bezel. Includes: faceplate and coupler/jack adapters.

Model #	lbs	list price
VDK-1	0.05	\$12

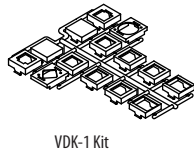

coupler/jack adapter kit:

Adapter	Manufacturer	Website
AA	Uniprise	www.UnipriseSolutions.com
BB	Tyco SL, and 110 Connect Series Modular Jacks	www.Ampconnect.com
BB	Siemon Keystone Style	www.Siemon.com
BB	Allen Tel Versa Tap Series	www.Allentel.com
BB	Leviton Quick Port [®] Series	www.Leviton.com
BB	Nordx Keystone Style	www.Nordx.com
CC	Tyco SL Coupler Series	www.Ampconnect.com
CC	Krone 6000 Series	www.Adc.com
CC	Hubbell Xcelerator [™] Keystone Series	www.Hubbell.com
DD	Blank (no coupler/jack)	
EE	Ortronics TracJack Series	www.Ortronics.com
FF	Panduit Mini-Com Series	www.Panduit.com
GG	Microphone jack/3-pin XLR, solder type only	
HH	Video Monitor jack/DB-15, panel mount solder style	

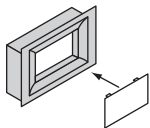

tile bezel cover – covers opening in tile bezel. Standard in textured black plastic.

Model #	lbs	list price
TBC-1	0.07	\$4

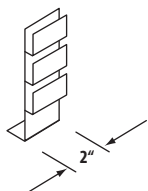

cable tree – attach to Simon frames to support voice/data cables. Cable trees needed only along cable route.

specify: one recommended per 24" and 30" wide panel
two recommended per 36"- 54" wide panel

Model #	lbs	list price
CT-1	0.07	\$8



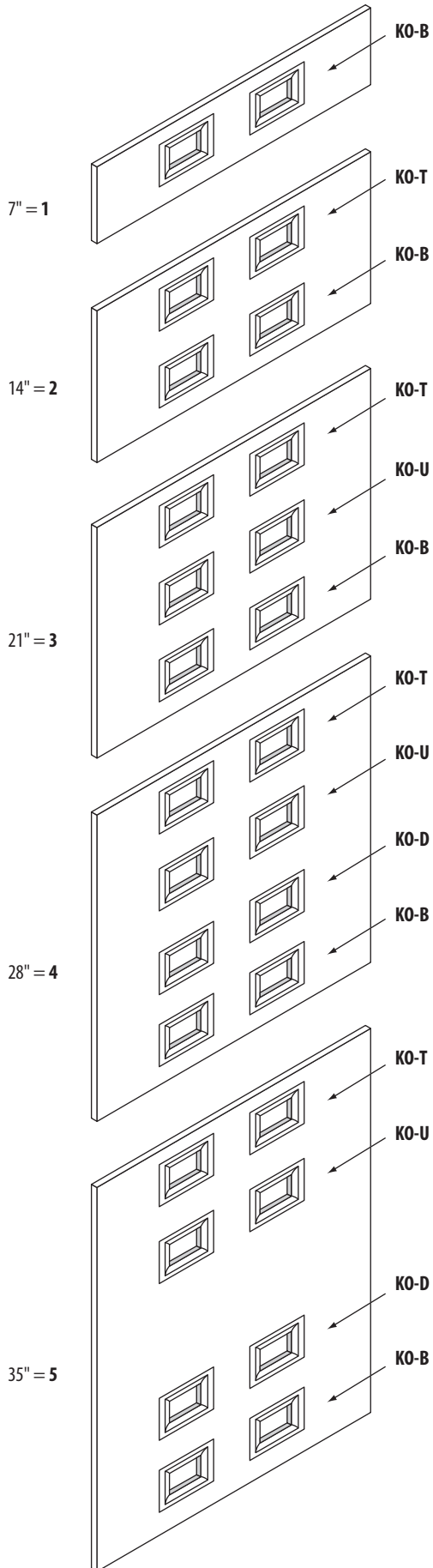

tile knock-outs – factory installed bezels are included with all tile knock-outs. To specify knock-outs, add the appropriate location as a suffix to the tile. If using multiple locations on a single tile, specify “KO-” only once (see example below).

price for knock-out is factored into the tile bezel on preceding page (model #B-1).

example configuration – using 30" wide fabric tiles:

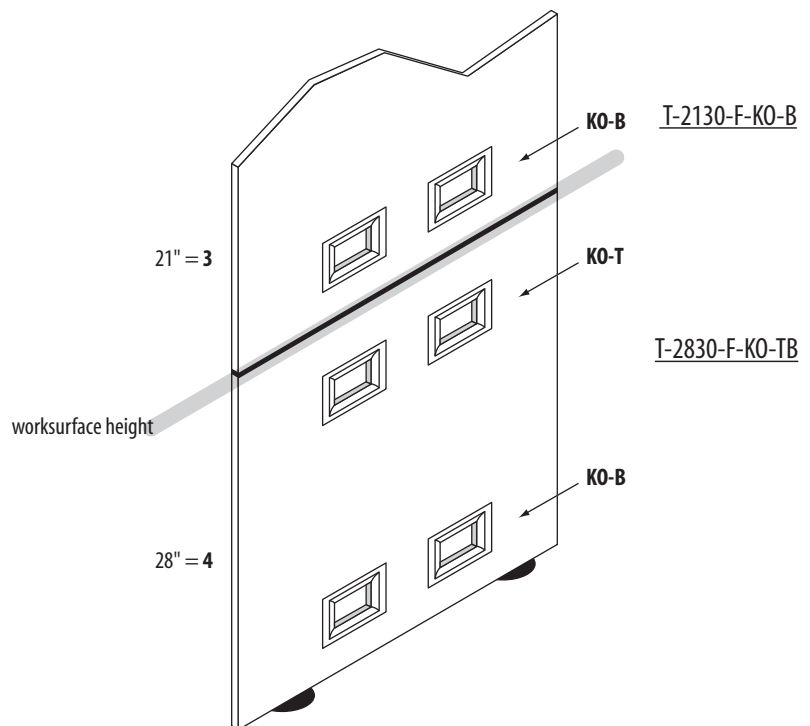

please specify:

- model number
- scallop / grommet position

see also:

- Simon worksurfaces (pp 34-48)

scallops - scallops are designed to allow for easy cord management and access to electrical outlets placed below worksurface.

S-1

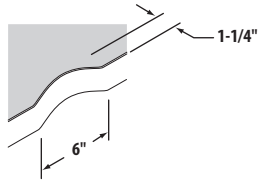

Model #	description	list price
S-1	scallop	\$33
G-1	grommet (black only)	24

G-1

2-1/2" dia. grommet with integrated cover. Black only.

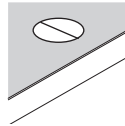

specifying – sketch Simon model and dimension accordingly:

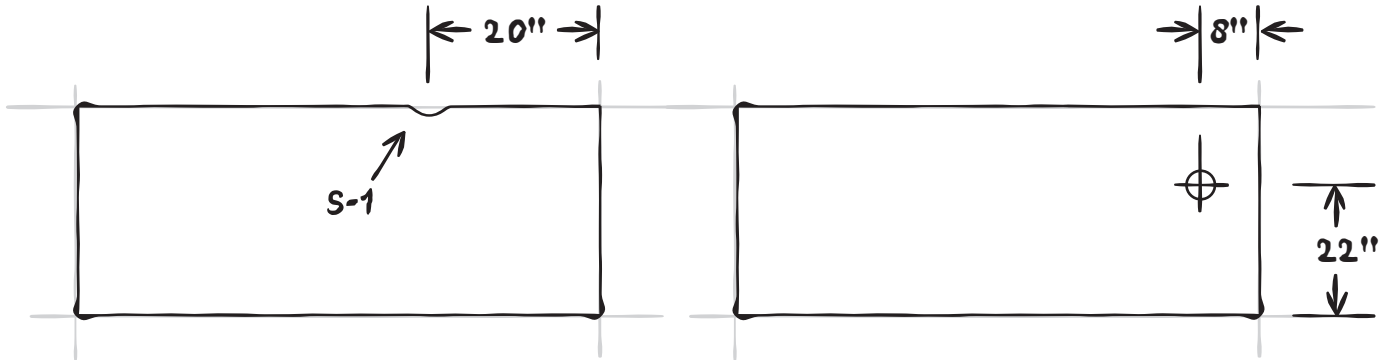

example: B-6024 with S-1

example: B-8430 with G-1



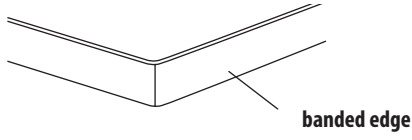

banded edge – “B”

3 mm PVC banded edged worksurfaces have squared corners and a soft front edge. Several colors are available, please refer to *Edge Selection Guide*.

specification example

model number: B-6024

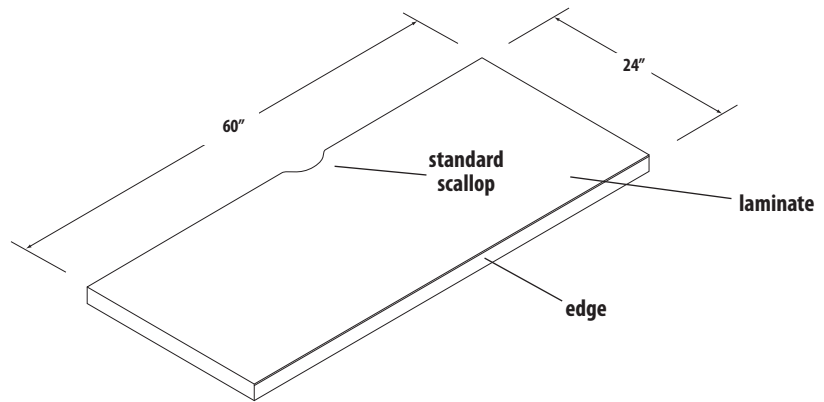

please specify:

- edge color
- laminate

see also:

- *Edge Selection Guide*
- scallop & grommet placement guide (page 32)
- worksurface accessories (page 51)

rectangular worksurfaces

Rectangular worksurfaces may be panel mounted, supported by a freestanding pedestal, double support leg or end panel (see below). Available in Banded-edge. For a list of available edge colors, please refer to *Edge Selection Guide*.

Rectangular worksurfaces shown with suggested center scallops, please add \$33 per scallop. To add or change scallop locations, please see page 32.

panel attachment and freestanding support components:



cantilevers
(page 58)



end panels
(page 59)



double support leg
(page 59)



pedestals
(page 60)

woodgrain direction:

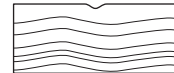

typical configurations:

corner configurations

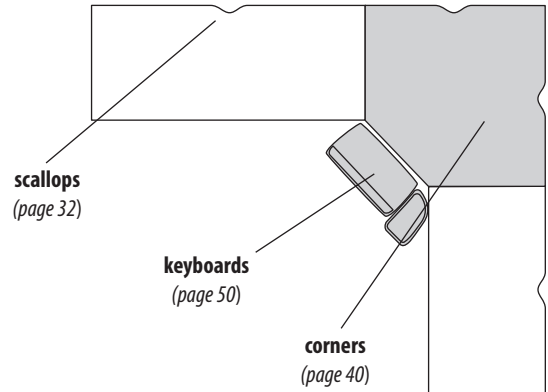
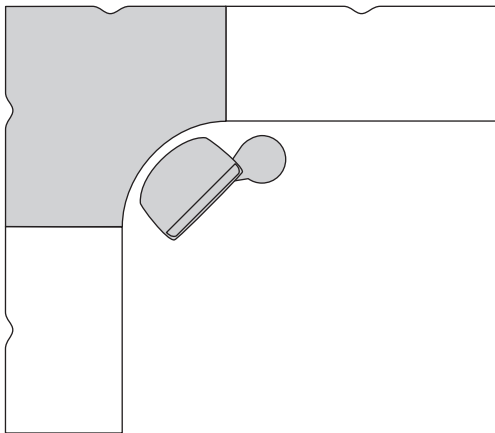

“L” configurations

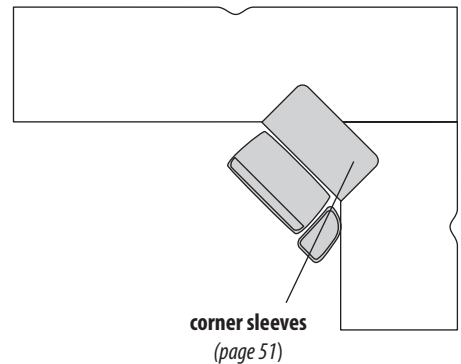
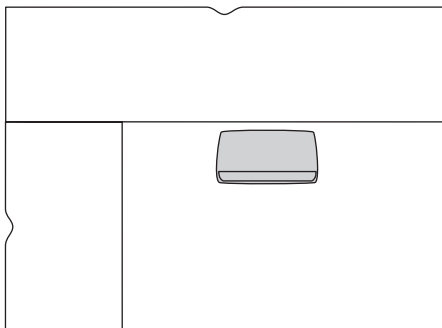

20" deep rectangular

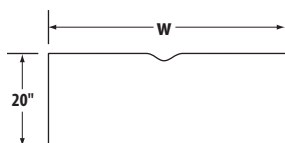

Model #	w	lbs	list price
			"B" (banded)
B-2420	24"	16	\$220
B-3020	30"	20	249
B-3620	36"	24	256
B-4220	42"	28	318
B-4820	48"	32	333
B-5420	54"	36	355
B-6020	60"	40	372
B-6620	66"	44	470
B-7220	72"	48	485
B-7820	78"	52	613
B-8420	84"	55	634
B-9020	90"	59	650
B-9620	96"	63	667

24" deep rectangular

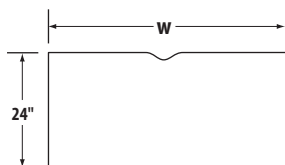

B-2424	24"	19	\$227
B-3024	30"	24	266
B-3624	36"	29	311
B-4224	42"	34	325
B-4824	48"	39	341
B-5424	54"	43	410
B-6024	60"	48	424
B-6624	66"	52	485
B-7224	72"	57	507
B-7824	78"	62	629
B-8424	84"	67	644
B-9024	90"	71	675
B-9624	96"	76	688

30" deep rectangular

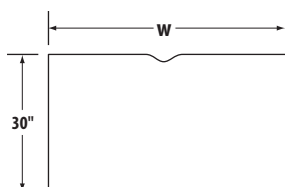

B-2430	24"	24	\$264
B-3030	30"	30	311
B-3630	36"	36	341
B-4230	42"	42	439
B-4830	48"	48	454
B-5430	54"	54	470
B-6030	60"	60	492
B-6630	66"	66	596
B-7230	72"	72	629
B-7830	78"	78	644
B-8430	84"	84	660
B-9030	90"	89	780
B-9630	96"	95	811

please specify:

- edge color
- laminate

see also:

- *Edge Selection Guide*
- scallop & grommet placement guide (page 32)
- worksurface accessories (page 51)

wave and jetty worksurfaces

Wave and jetty worksurfaces may be panel mounted, supported by a double support leg or end panel (see below). Wave worksurfaces may also be supported by a freestanding pedestal. Available in Banded-edge. For a list of available edge colors, please refer to *Edge Selection Guide*.

Wave and jetty worksurfaces shown with suggested center scallops, please add \$33 per scallop. To add or change scallop locations, please see page 32.

panel attachment and freestanding support components:



cantilevers
(page 58)



end panels
(page 59)



double support leg
(page 59)



pedestals
(page 60)

woodgrain direction:



typical configurations:

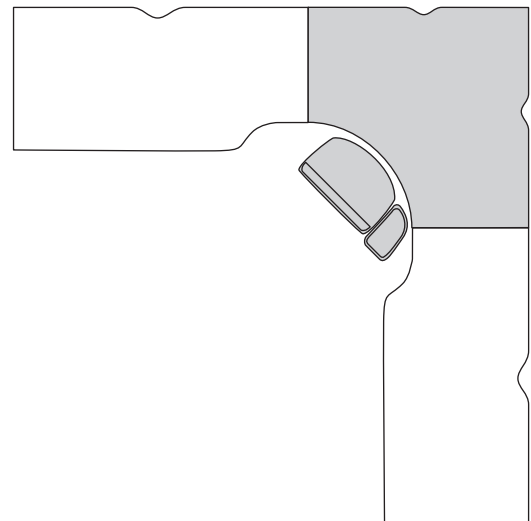
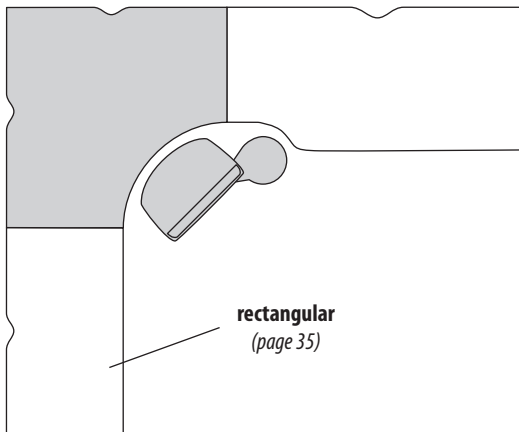
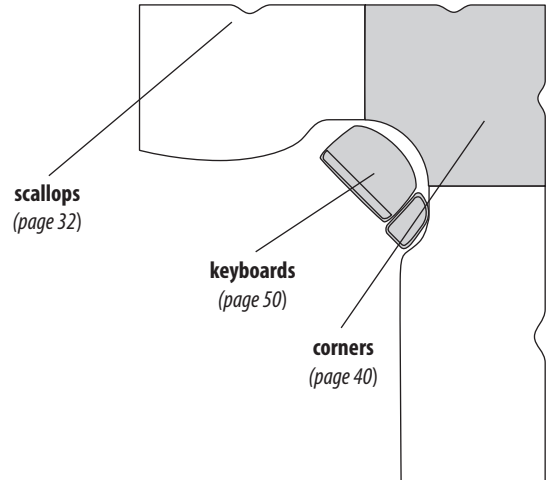
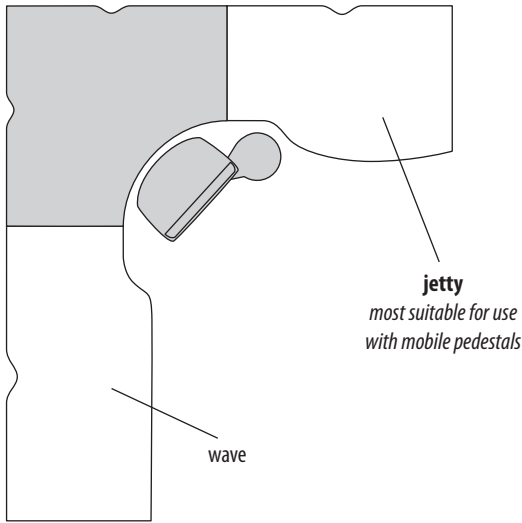

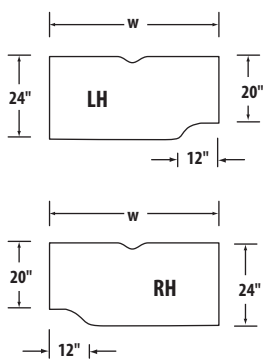
	left hand		right hand		list price	
	Model #	Model #	w	lbs	"B" (banded)	
20" - 24" wave 	WB-302024L	WB-302024R	30"	24	\$307	
	WB-362024L	WB-362024R	36"	30	389	
	WB-422024L	WB-422024R	42"	36	404	
	WB-482024L	WB-482024R	48"	42	422	
	WB-542024L	WB-542024R	54"	48	504	
	WB-602024L	WB-602024R	60"	54	526	
	WB-662024L	WB-662024R	66"	60	608	
	WB-722024L	WB-722024R	72"	66	625	

24" - 30" wave 	WB-302430L	WB-302430R	30"	30	\$365	
	WB-362430L	WB-362430R	36"	36	397	
	WB-422430L	WB-422430R	42"	42	535	
	WB-482430L	WB-482430R	48"	48	542	
	WB-542430L	WB-542430R	54"	54	591	
	WB-602430L	WB-602430R	60"	60	602	
	WB-662430L	WB-662430R	66"	66	729	
	WB-722430L	WB-722430R	72"	72	779	

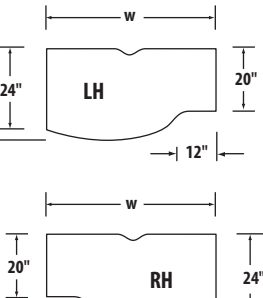
	left hand		right hand		list price	
	Model #	Model #	w	lbs	"B" (banded)	
20" - 24" jetty 	JB-302024L	JB-302024R	30"	24	\$365	
	JB-362024L	JB-362024R	36"	30	397	
	JB-422024L	JB-422024R	42"	36	535	
	JB-482024L	JB-482024R	48"	42	542	
	JB-542024L	JB-542024R	54"	48	592	
	JB-602024L	JB-602024R	60"	54	602	
	JB-662024L	JB-662024R	66"	60	729	
	JB-722024L	JB-722024R	72"	66	779	

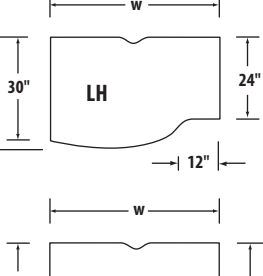
24" - 30" jetty 	JB-302430L	JB-302430R	30"	30	\$462	
	JB-362430L	JB-362430R	36"	36	551	
	JB-422430L	JB-422430R	42"	42	647	
	JB-482430L	JB-482430R	48"	48	729	
	JB-542430L	JB-542430R	54"	54	803	
	JB-602430L	JB-602430R	60"	60	859	
	JB-662430L	JB-662430R	66"	66	1069	
	JB-722430L	JB-722430R	72"	72	1159	



please specify:

- edge color
- laminate

see also:

- *Edge Selection Guide*
- scallop & grommet placement guide (*page 32*)

corner worksurfaces

Corner worksurfaces may be panel mounted, supported by a double support leg or end panel (see below). Available in Banded-edge. For a list of available edge colors, please refer to *Edge Selection Guide*.

Corner worksurfaces are shown with suggested center scallops on both sides, please add \$33 per scallop. To add or change scallop locations, please see *page 32*.

panel attachment and freestanding support components:

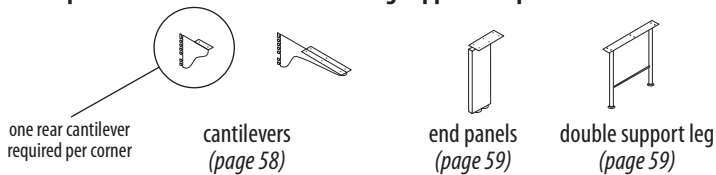

woodgrain direction:



typical configurations:

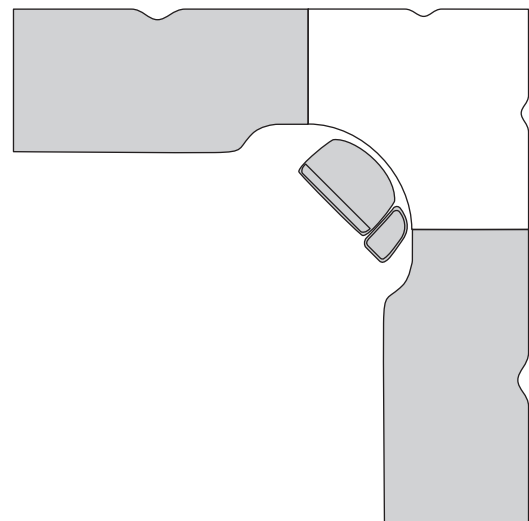
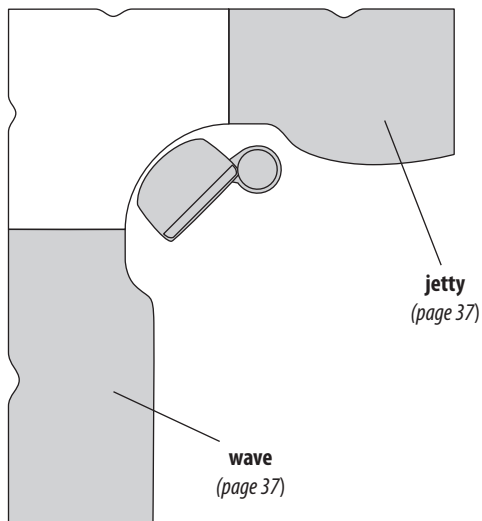
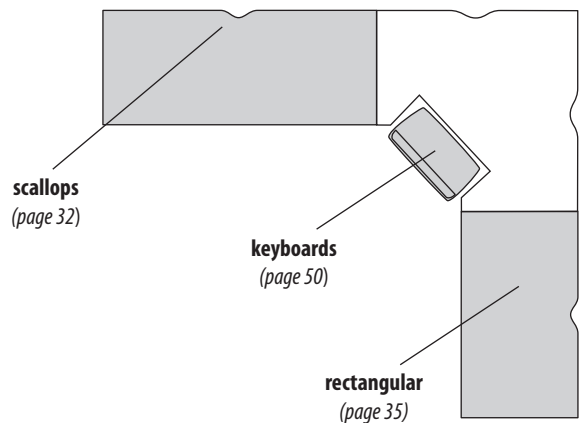
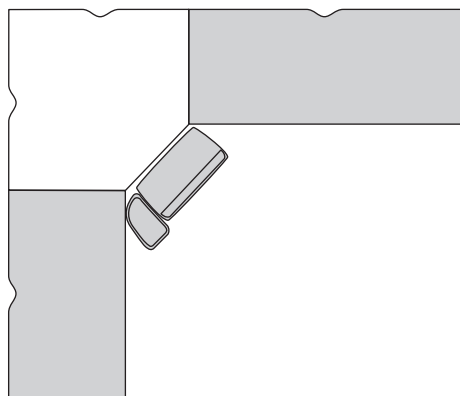

basic corner

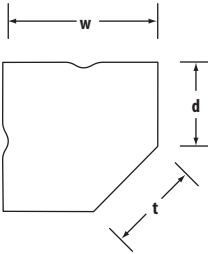

					list price	
<i>Model #</i>	<i>w</i>	<i>d</i>	<i>t</i>	<i>lbs</i>	<i>"B" (banded)</i>	
20" deep	CB-3620	36"	20"	23"	38	\$530
	CB-4220	42"	20"	31"	50	681
24" deep	CB-3624	36"	24"	17"	40	\$559
	CB-4224	42"	24"	25"	42	696
	CB-4824	48"	24"	34"	66	780
30" deep	CB-4230	42"	30"	17"	55	\$720
	CB-4830	42"	30"	25"	71	797

radius corner

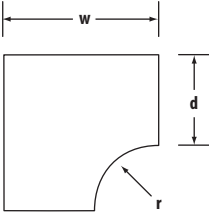

					list price	
<i>Model #</i>	<i>w</i>	<i>d</i>	<i>r</i>	<i>lbs</i>	<i>"B" (banded)</i>	
20" deep	RCB-3620	36"	20"	16"	36	\$575
	RCB-4220	42"	20"	18"	47	720
24" deep	RCB-3624	36"	24"	12"	37	\$591
	RCB-4224	42"	24"	18"	48	734
	RCB-4824	48"	24"	24"	62	811
30" deep	RCB-4230	42"	30"	12"	52	\$751
	RCB-4830	48"	30"	18"	67	825

radius transition
corner worksurfaces

please specify:

- edge color
- laminate

see also:

- *Edge Selection Guide*
- *scallop & grommet placement guide (page 32)*
- *cantilevers or support components (see pp 58-59)*

20"-24" radius transition

					list price
Model #	Model #	w	r	lbs	"B" (banded)
NCB-362024L	NCB-362024R	36"	14"	37	\$622
NCB-422024L	NCB-422024R	42"	18"	48	765
NCB-482024L	NCB-482024R	48"	18"	62	840

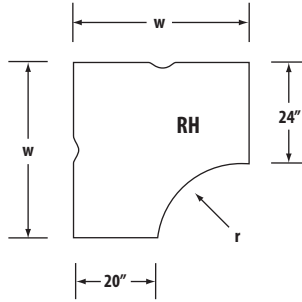
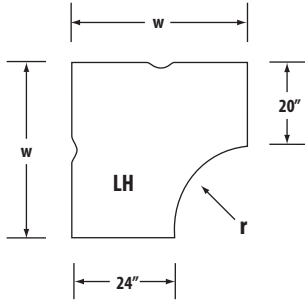

24"-30" radius transition

					list price
Model #	Model #	w	r	lbs	"B" (banded)
NCB-422430L	NCB-422430R	42"	16"	52	\$797
NCB-482430L	NCB-482430R	48"	18"	67	877

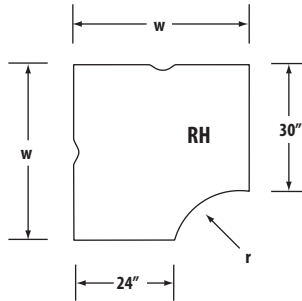
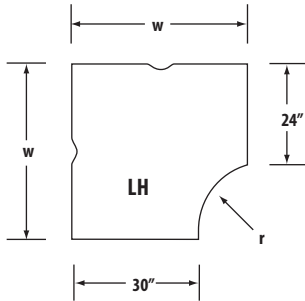



"L" shaped radius corner

please specify:

- edge color
- laminate

see also:

- *Edge Selection Guide*
- scallop & grommet placement guide (page 32)
- worksurface accessories (page 51)

"L" shaped corner worksurfaces

"L" shaped corner worksurfaces may be panel mounted, supported by a double support leg or end panel (see below). Available in Banded-edge. For a list of available edge colors, please refer to *Edge Selection Guide*.

"L" shaped corner worksurfaces are shown with suggested 3 scallop configuration, please add \$33 per scallop. To add or change scallop locations, please see page 32.

panel attachment and freestanding support components:

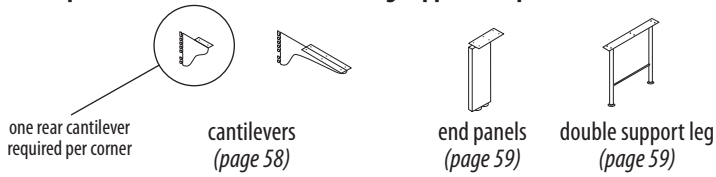

woodgrain direction:

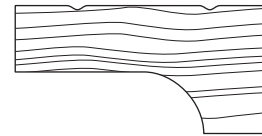

typical configurations:

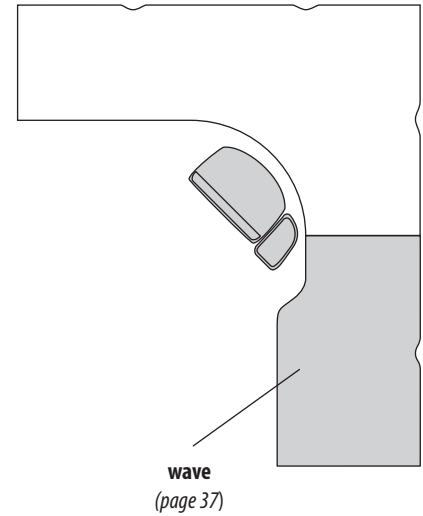
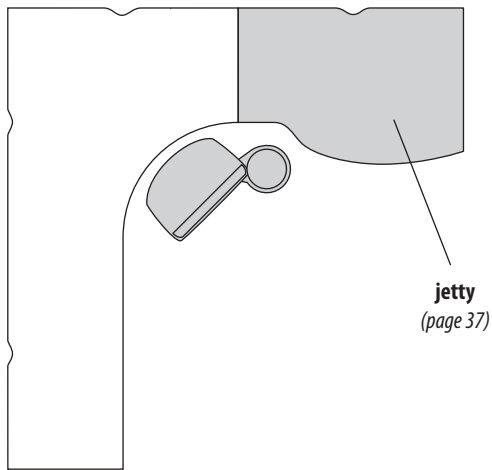

36" "L" shaped radius corner

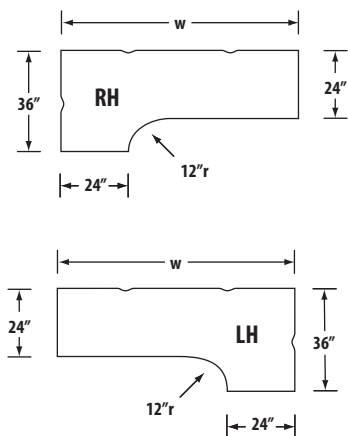

left hand		right hand		list price	
Model #	Model #	w	lbs	"B" (banded)	
LB-483624L	LB-483624R	48"	52	\$631	
LB-543624L	LB-543624R	54"	57	714	
LB-603624L	LB-603624R	60"	63	734	
LB-663624L	LB-663624R	66"	67	825	
LB-723624L	LB-723624R	72"	72	878	
LB-783624L	LB-783624R	78"	75	986	
LB-843624L	LB-843624R	84"	78	1067	
LB-903624L	LB-903624R	90"	82	1127	
LB-963624L	LB-963624R	96"	86	1278	

42" "L" shaped radius corner

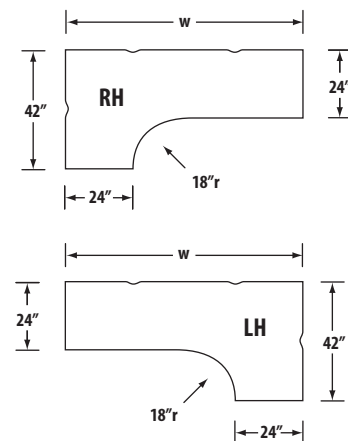

left hand		right hand		list price	
Model #	Model #	w	lbs	"B" (banded)	
LB-484224L	LB-484224R	48"	54	\$891	
LB-544224L	LB-544224R	54"	59	931	
LB-604224L	LB-604224R	60"	65	954	
LB-664224L	LB-664224R	66"	69	1075	
LB-724224L	LB-724224R	72"	73	1090	
LB-784224L	LB-784224R	78"	77	1114	
LB-844224L	LB-844224R	84"	80	1158	
LB-904224L	LB-904224R	90"	84	1209	
LB-964224L	LB-964224R	96"	88	1278	

48" "L" shaped radius corner

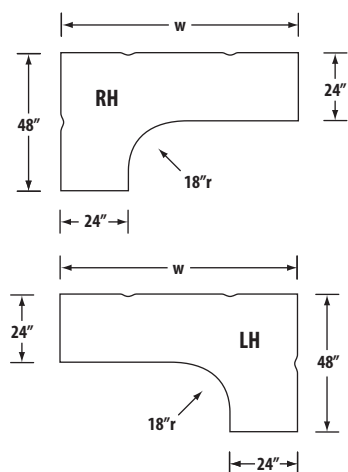

left hand		right hand		list price	
Model #	Model #	w	lbs	"B" (banded)	
LB-544824L	LB-544824R	54"	63	\$997	
LB-604824L	LB-604824R	60"	69	1036	
LB-664824L	LB-664824R	66"	73	1127	
LB-724824L	LB-724824R	72"	77	1158	
LB-784824L	LB-784824R	78"	81	1197	
LB-844824L	LB-844824R	84"	84	1246	
LB-904824L	LB-904824R	90"	88	1258	
LB-964824L	LB-964824R	96"	92	1312	



please specify:

- edge color
- laminate

see also:

- *Edge Selection Guide*

u-turn and elbow worksurfaces

U-turn and elbow worksurfaces are panel mounted on the transition ends and supported by a single or double support leg on the extended portion of the worksurface (*see below*). Available in Banded-edge. For a list of available edge colors, please refer to *Edge Selection Guide*.

U-turn and elbow worksurfaces do not have scallops.

panel attachment and freestanding support components:

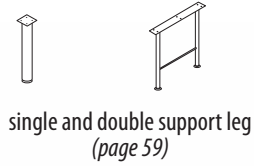
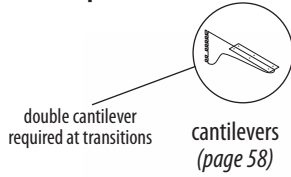

woodgrain direction:



typical configurations:

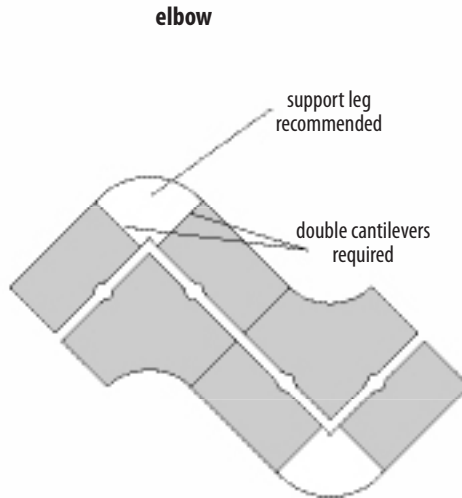
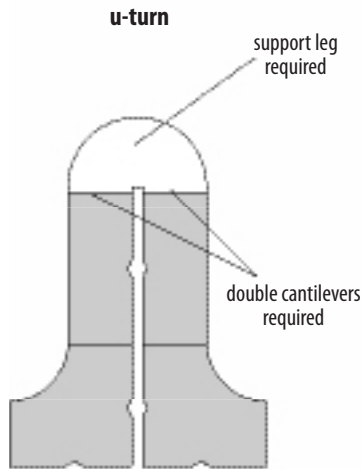

					list price					
					"B" (banded)					
Model #	w	d	r	lbs						
u-turn	for 20" deep worksurfaces				UB-2020	43-5/8"	22"	22"	25	\$454
	for 24" deep worksurfaces				UB-2424	51-5/8"	26"	26"	35	\$602
	for 30" deep worksurfaces				UB-3030	63-5/8"	32"	32"	53	\$729

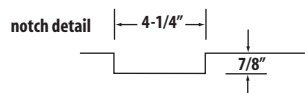
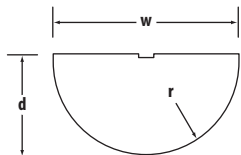

					list price				
					"B" (banded)				
Model #	x	r	lbs						
elbow	for 20" deep worksurfaces				EB-20	23-3/4"	23-3/4"	13	\$235
	for 24" deep worksurfaces				EB-24	27-3/4"	27-3/4"	18	\$316
	for 30" deep worksurfaces				EB-30	33-3/4"	33-3/4"	27	\$493

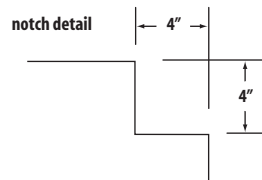
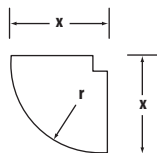

please specify:

- edge color
- laminate

see also:

- *Edge Selection Guide*
- scallop & grommet placement guide (page 32)
- worksurface accessories (page 51)

peninsula worksurfaces

Peninsula worksurfaces can be panel mounted and supported by a single or double support leg on the extended portion of the worksurface (see below). Available in Banded-edge. For a list of available edge colors, please refer to *Edge Selection Guide*.

Peninsula worksurfaces are shown with a single scallop, please add \$33 per scallop. To add or change scallop locations, please see page 32

panel attachment and freestanding support components:



cantilevers
(page 58)



end panels
(page 59)

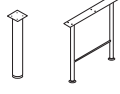

tube legs
(page 59)



pedestals
(page 60)

woodgrain direction:



typical configurations:

basic

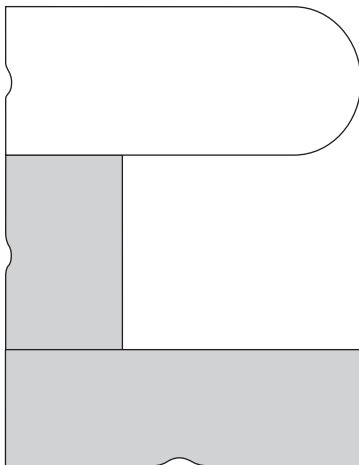

"P" shaped

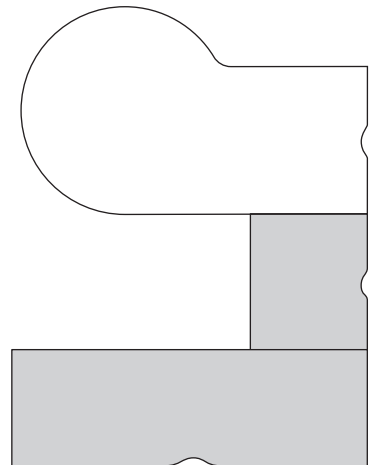

"L" shaped

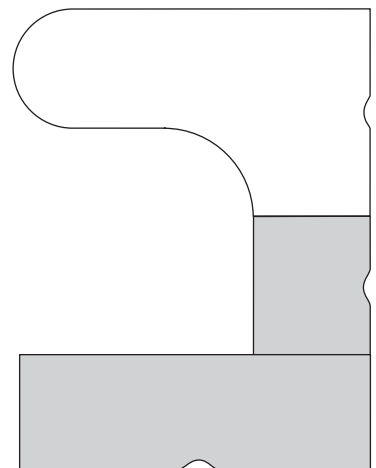

30" basic peninsula

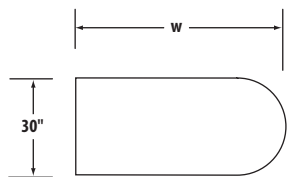

Model #	w	lbs	list price
			"B" (banded)
PB-4830	48"	45	\$522
PB-5430	54"	51	559
PB-6030	60"	57	575
PB-6630	66"	63	681
PB-7230	72"	69	734
PB-7830	78"	75	751
PB-8430	84"	81	765
PB-9030	90"	86	854
PB-9630	96"	92	924

36" basic peninsula

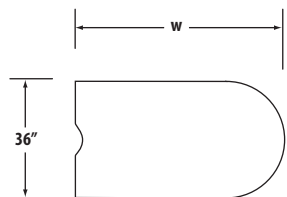

PB-4836	48"	53	\$634
PB-5436	54"	60	696
PB-6036	60"	68	734
PB-6636	66"	74	854
PB-7236	72"	80	916
PB-7836	78"	87	940
PB-8436	84"	95	969
PB-9036	90"	103	1075
PB-9636	96"	110	1153

30" "P" shaped peninsula

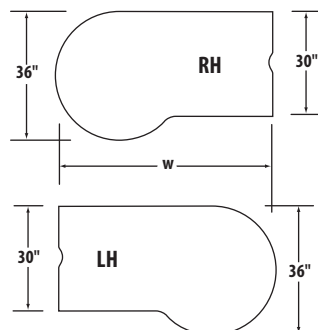

left hand		right hand		list price
Model #	Model #	w	lbs	"B" (banded)
PPB-6030L	PPB-6030R	60"	69	\$853
PPB-6630L	PPB-6630R	66"	74	940
PPB-7230L	PPB-7230R	72"	80	1036
PPB-7830L	PPB-7830R	78"	86	1316
PPB-8430L	PPB-8430R	84"	92	1354
PPB-9030L	PPB-9030R	90"	97	1385
PPB-9630L	PPB-9630R	96"	103	1442

36" "P" shaped peninsula

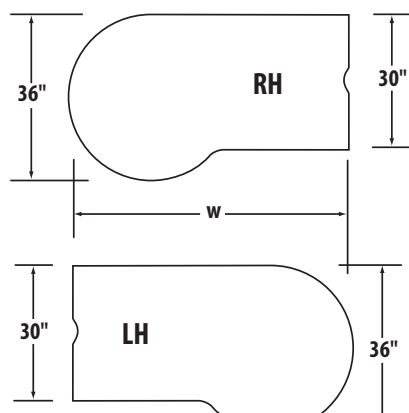

left hand		right hand		list price
Model #	Model #	w	lbs	"B" (banded)
PPB-6036L	PPB-6036R	60"	69	\$891
PPB-6636L	PPB-6636R	66"	74	969
PPB-7236L	PPB-7236R	72"	80	1052
PPB-7836L	PPB-7836R	78"	86	1332
PPB-8436L	PPB-8436R	84"	92	1371
PPB-9036L	PPB-9036R	90"	97	1400
PPB-9636L	PPB-9636R	96"	103	1458



"L" shaped peninsulas & hockey stick units

please specify:

- edge color
- laminate

see also:

- *Edge Selection Guide*
- *scallop & grommet placement guide (page 32)*
- *cantilevers or support components (see pp 58-59)*

• *worksurface accessories (page 51)*

42" deep radius "L" shaped

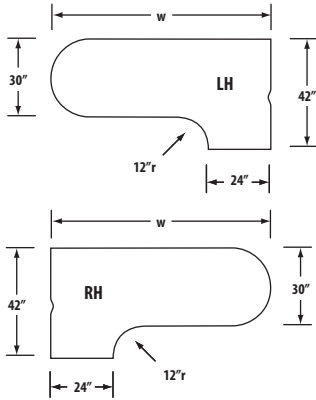

left hand		right hand		list price	
Model #	Model #	w	lbs	"B" (banded)	
LPB-664230L	LPB-664230R	66"	74	\$983	
LPB-724230L	LPB-724230R	72"	80	1016	
LPB-784230L	LPB-784230R	78"	86	1285	
LPB-844230L	LPB-844230R	84"	92	1332	
LPB-904230L	LPB-904230R	90"	97	1400	

42" deep radius "L" shaped "P" peninsula

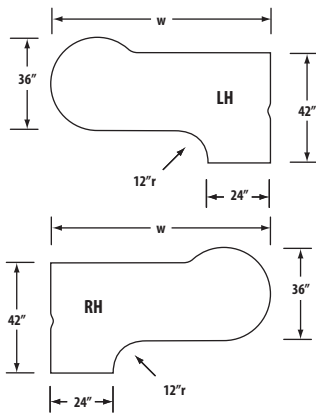

left hand		right hand		list price	
Model #	Model #	w	lbs	"B" (banded)	
LPPB-664230L	LPPB-664230R	66"	78	\$1021	
LPPB-724230L	LPPB-724230R	72"	85	1052	
LPPB-784230L	LPPB-784230R	78"	91	1316	
LPPB-844230L	LPPB-844230R	84"	97	1371	
LPPB-904230L	LPPB-904230R	90"	102	1430	

hockey stick unit

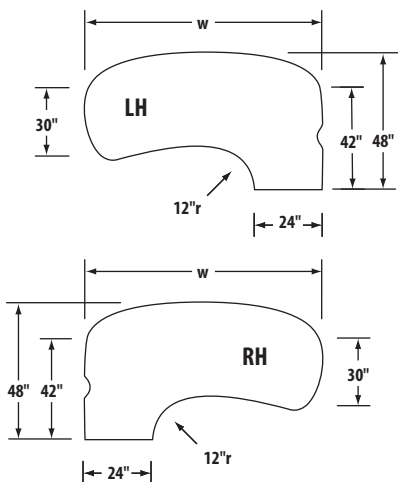

left hand		right hand		list price	
model #	model #	w	lbs	"B" (banded)	
HSB-724224L	HSB-724224R	72"	77	\$1241	
HSB-784224L	HSB-784224R	78"	81	1266	
HSB-844224L	HSB-844224R	84"	84	1309	
HSB-904224L	HSB-904224R	90"	88	1361	





please specify:
• model number

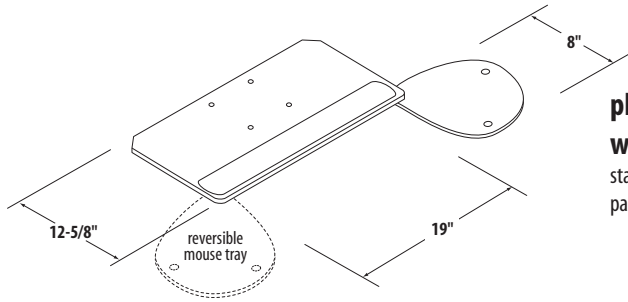

phenolic keyboard platform with reversible mouse tray – standard with Stasoft™ synthetic leather palm support.

Model #	w	d	lbs	list price
MP19	19"	9-1/2"	3	\$272
MP19-LA	19"	12"	3	284

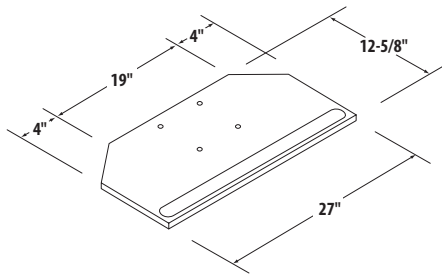

phenolic mouse-width platform – standard with Stasoft™ synthetic leather palm support. Mouse width, black only.

Model #	w	d	lbs	list price
SP27	27"	9-1/2"	4	\$196
SP27-LA	27"	12"	4	208

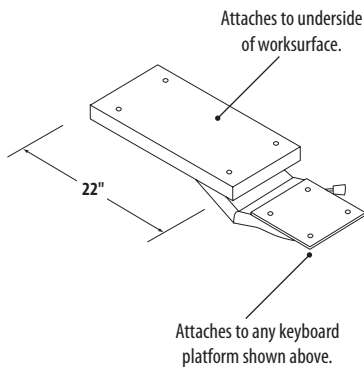

passive adjust keyboard mechanism – adjustments include: platform tilt ($\pm 15^\circ$), up/down, in/out, and 360° rotation. Up/down adjustment is spring assisted and is controlled by simply lifting up on the front of the attached platform. Features a slim-line profile beneath the platform. Available in black only.

Standard

Model #	w	d	lbs	list price
PA-22	5"	22"	11	\$269
PA-17	5"	17"	10	275

Sit/Stand

Model #	w	d	h	lbs	list price
PA22-SS	5"	22"	24" - 38"	11	\$347

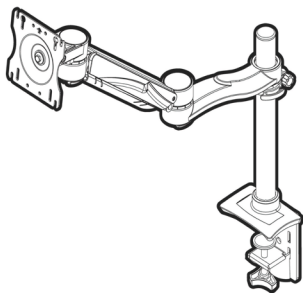

sit/stand monitor arm – adjustments include: swivels, tilts, moves in & out, up & down. Moving monitor from seated to standing height is quick and easy. Grommet or clamp mounts. Available in black only. VESA compatible. 20 pound capacity.

Model #	w	d	h	lbs	list price
SS-7818H	5"	7"	7" - 25"	6	\$508



please specify:

- model number
- coating color (corner sleeve)

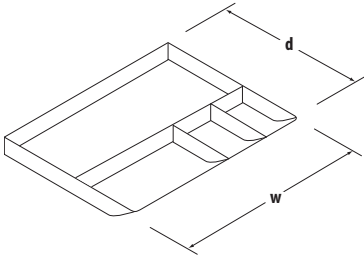

pencil drawer –

self contained pencil drawer is designed to attach to the underside of any Simon worksurface. Mounting hardware included. Available in black only.

Model #	w	d	lbs	list price
PPT-1	20-1/2"	22"	3	\$166

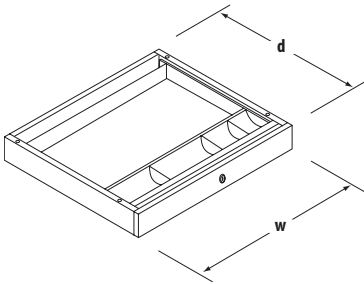

security drawer –

self contained, secure and strong. Accommodates laptop computers up to 11-1/4" d x 1-5/8" h x 19-1/2" w. Pencil tray included. Entire unit doubles as a pencil drawer. Standard with Lock. Specify enamel color.

with lock

Model #	w	d	h	lbs	list price
SD-21L	21-3/8"	21"	2-7/8"	12	287

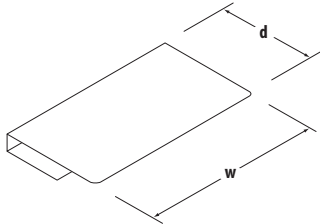

corner sleeve –

transforms a 90° corner into a corner computer workstation. Attaches to Simon worksurfaces with included hardware. Specify enamel color.

Model #	w	d	lbs	list price
CS-17	17"	10-5/8"	5	\$116
CS-21	21"	10-5/8"	6	116

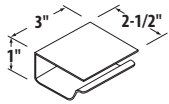

horizontal cable trough – horizontal cable management trough. For field installation only. Attaches to underside of worksurface with screws. Sold in packages of four which include screws.

Model #	w	lbs	list price
HCT-4	3"	1.4	\$39 (per package of 4)



please specify:

- edge color
- laminate

see also:

- *Edge Selection Guide*

pill countertops

Pill countertops are mounted to support posts which are enclosed by a counter top cap and bolted directly to the internal Simon frame (*see below*). Available in Banded-edge. For a list of available edge colors, please refer to *Edge Selection Guide*.

panel attachment components:

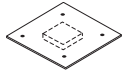

counter post
(page 58)

NOTE: Support posts will not mount directly above plexi or glass tiles.

woodgrain direction:



typical configurations:

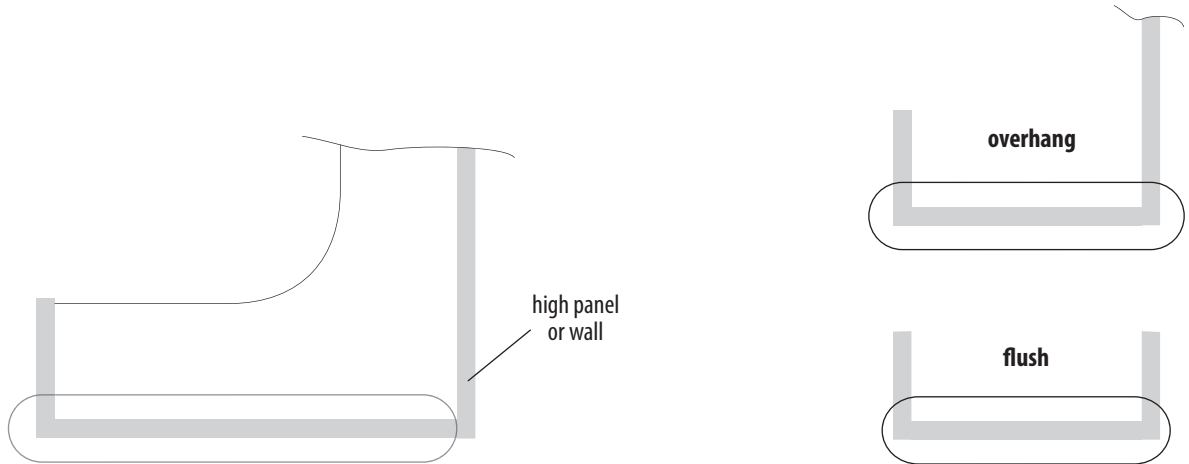

pill

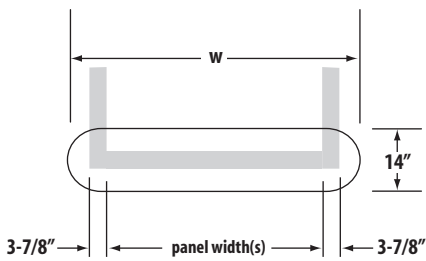

Use the above drawing to determine desired overhang.

Model #	w	lbs	list price
			"B" (banded)
PLB-3614	36"	17	\$250
PLB-4214	42"	19	260
PLB-4814	48"	22	269
PLB-5414	54"	25	300
PLB-6014	60"	28	333
PLB-6614	66"	31	383
PLB-7214	72"	33	454
PLB-7814	78"	36	504
PLB-8414	84"	39	526
PLB-9014	90"	42	535
PLB-9614	96"	44	569



- edge color
- laminate

• *Edge Selection Guide*

bullet countertops

Bullet countertops are mounted to support posts which are enclosed by a counter top cap and bolted directly to the internal Simon frame (see below). Available in Banded-edge. For a list of available edge colors, please refer to *Edge Selection Guide*.

required attachment components:

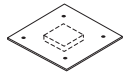

counter post
(page 58)

NOTE: Support posts will not mount directly above plexi or glass tiles.

woodgrain direction:



typical configurations:

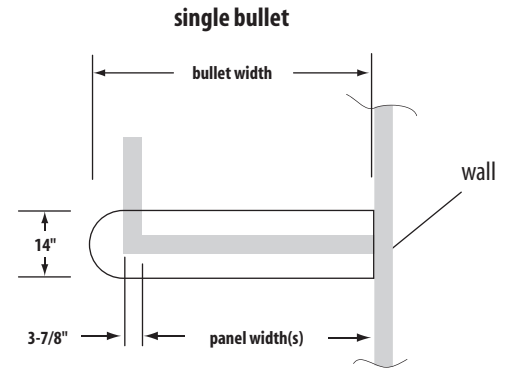
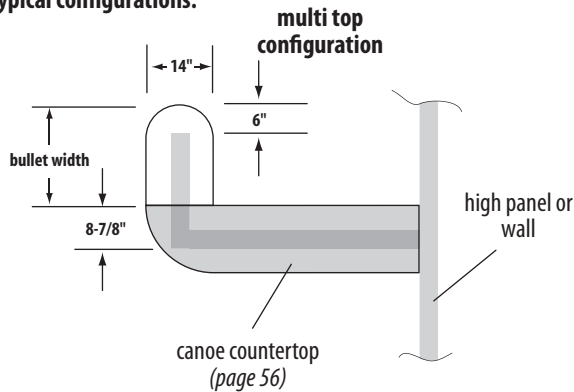

multi top bullet

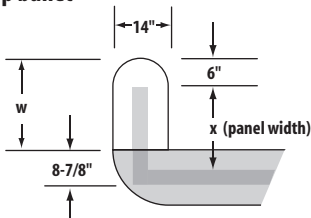

NOTE: bullet countertop width 'w' accounts for the adjacent top, panel width 'x' and end cap.

single bullet

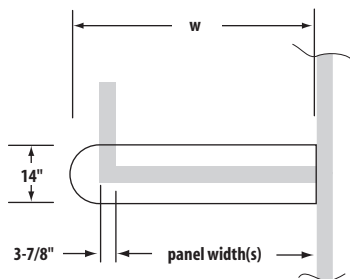

Use the above drawing to determine desired overhang.

Model #	x	w	lbs	list price	
				"B" (banded)	
BUB-2614	24"	26"	12	243	
BUB-3214	30"	32"	14	250	
BUB-3814	36"	38"	17	260	
BUB-4414	42"	44"	20	269	
BUB-5014	48"	50"	23	300	
BUB-5614	54"	56"	26	332	

Model #	w	lbs	"B" (banded)
BUB-3614	36"	17	\$243
BUB-4214	42"	19	250
BUB-4814	48"	22	260
BUB-5414	54"	25	269
BUB-6014	60"	28	300
BUB-6614	66"	31	332
BUB-7214	72"	33	454
BUB-7814	78"	36	504
BUB-8414	84"	39	526
BUB-9014	90"	42	535
BUB-9614	96"	44	569



please specify:

- edge color
- laminate

see also:

- *Edge Selection Guide*

box countertops

Box countertops are mounted to support posts which are enclosed by a counter top cap and bolted directly to the internal Simon frame (*see below*). Available in Banded-edge. For a list of available edge colors, please refer to *Edge Selection Guide*.

required attachment components:

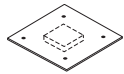

counter post
(page 58)

NOTE: Support posts will not mount directly above plexi or glass tiles.

woodgrain direction:

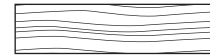

typical configurations:

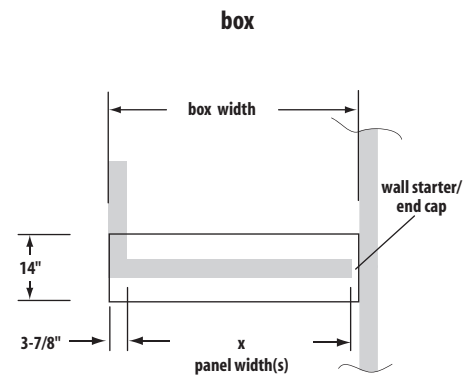
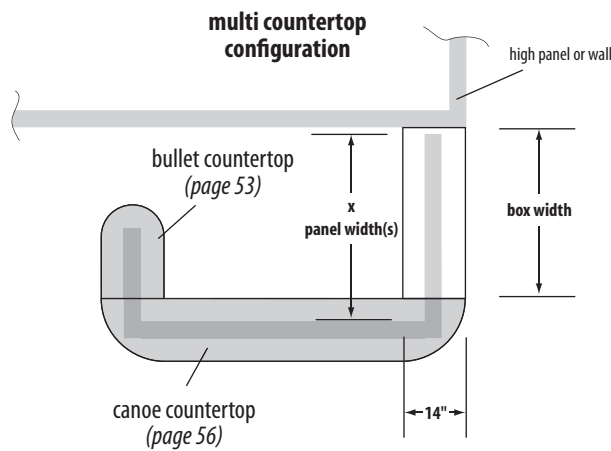

multi countertop box

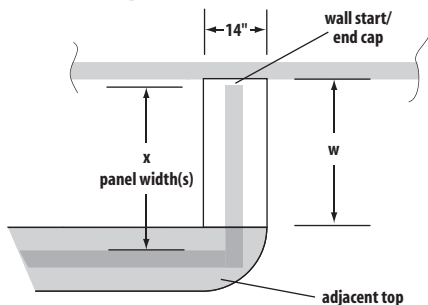

NOTE: box countertop width 'w' accounts for the adjacent top, panel width 'x' and wall start/end cap.

Model #	x	w	lbs	list price
				"B" (banded)
BXB-2614	30"	25-3/4"	14	\$235
BXB-3214	36"	31-3/4"	17	250
BXB-3814	42"	37-3/4"	19	260
BXB-4414	48"	43-3/4"	22	269
BXB-5014	54"	49-3/4"	25	300
BXB-5614	60"	55-3/4"	28	333
BXB-6214	66"	61-3/4"	31	389
BXB-6814	72"	67-3/4"	33	454
BXB-7414	78"	73-3/4"	36	504
BXB-8014	84"	79-3/4"	39	526
BXB-8614	90"	85-3/4"	42	535
BXB-9214	96"	91-3/4"	44	569

single box

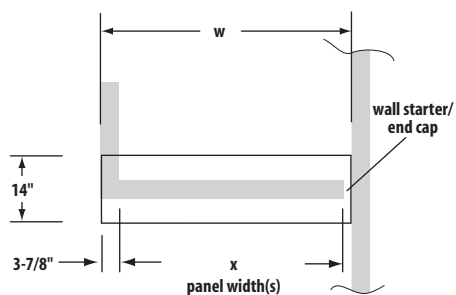

Model #	x	w	lbs	list price
				"B" (banded)
BXB-4114	36"	40-3/4"	21	\$260
BXB-4714	42"	46-3/4"	24	269
BXB-5314	48"	52-3/4"	26	300
BXB-5914	54"	58-3/4"	28	333
BXB-6514	60"	64-3/4"	31	389
BXB-7114	66"	70-3/4"	33	454
BXB-7714	72"	76-3/4"	35	504
BXB-8314	78"	82-3/4"	37	526
BXB-8914	84"	88-3/4"	40	535
BXB-9514	90"	94-3/4"	43	569



please specify:

- edge color
- laminate

see also:

• *Edge Selection Guide*

canoe and fin countertops

Canoe and fin countertops are mounted to support posts which are enclosed by a counter top cap and bolted directly to the internal Simon frame (see below). Available in Banded-edge. For a list of available edge colors, please refer to *Edge Selection Guide*.

panel attachment components:

woodgrain direction:

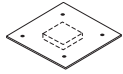

counter post
(page 58)

NOTE: Support posts will not mount directly above plexi or glass tiles.

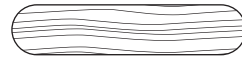

typical configurations:

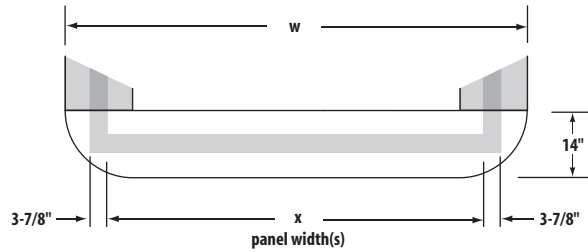

canoe configuration

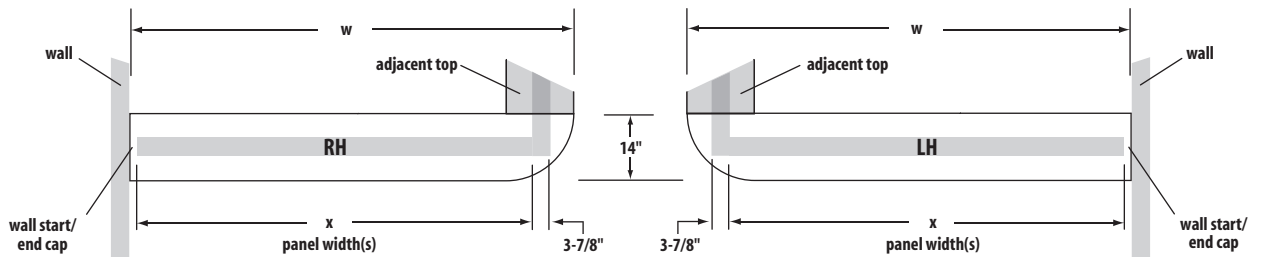

fin configuration



canoe

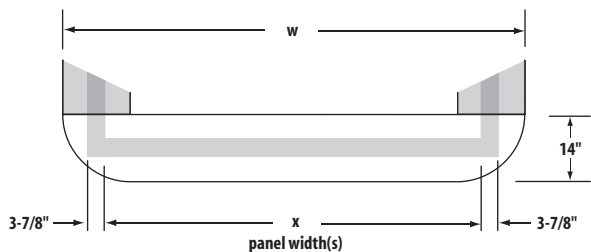

Model #	x	w	lbs	list price
				"B" (banded)
COB-5414	36"	53-3/4"	22	\$314
COB-6014	42"	59-3/4"	25	348
COB-6614	48"	65-3/4"	28	409
COB-7214	54"	71-3/4"	30	454
COB-7814	60"	77-3/4"	33	504
COB-8414	66"	83-3/4"	36	526
COB-9014	72"	89-3/4"	39	535
COB-9614	78"	95-3/4"	41	569

NOTE: fin countertop width 'w' accounts for the adjacent top, panel width 'x' and wall start/end cap.

fin

left hand		right hand		lbs	list price
Model #	Model #	x	w		"B" (banded)
FNB-4514L	FNB-4514R	36"	45-5/8"	20	\$282
FNB-5114L	FNB-5114R	42"	51-5/8"	23	314
FNB-5714L	FNB-5714R	48"	57-5/8"	25	348
FNB-6314L	FNB-6314R	54"	63-5/8"	28	389
FNB-6914L	FNB-6914R	60"	69-5/8"	31	454
FNB-7514L	FNB-7514R	66"	75-5/8"	34	504
FNB-8114L	FNB-8114R	72"	81-5/8"	36	526
FNB-8714L	FNB-8714R	78"	87-5/8"	39	536
FNB-9314L	FNB-9314R	84"	93-5/8"	42	569

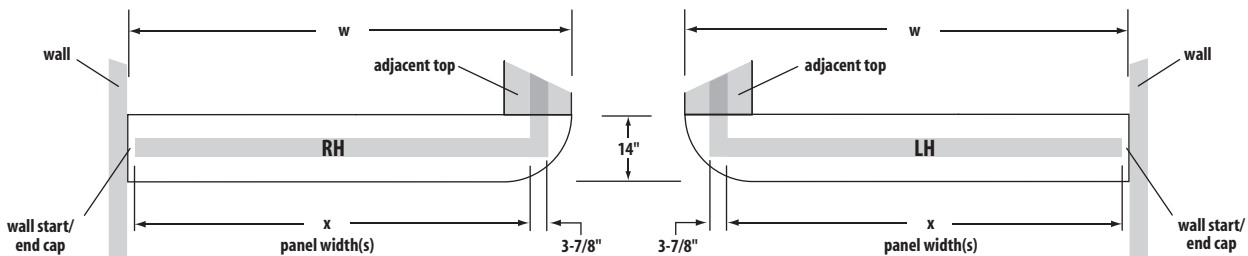

NOTE: fin countertop width 'w' accounts for the adjacent top, panel width 'x' and wall start/end cap.



please specify:

- model number
- coating color (countertop support)

worksurface support

Cantilevers are the primary support for panel mounted worksurfaces and are designed to attach to the end rails between each Simon frame. Cantilevers come in left-hand, right-hand, double and short versions and are standard in matte black. Mounting screws included.

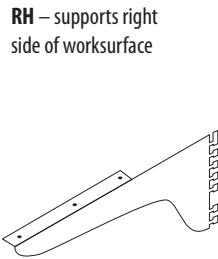
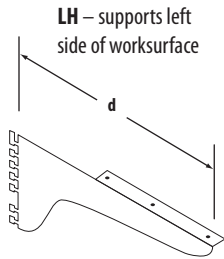

left hand		right hand			
Model #	Model #	d	worksurface depth	lbs	list price
SCL-18L	SCL-18R	18"	20" & 24"	2	\$39
SCL-22L	SCL-22R	22"	24" & 30"	2	39

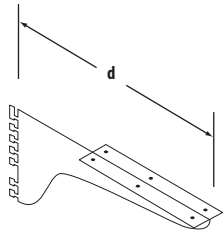

double –
adjoins two worksurfaces

Model #	d	worksurface depth	lbs	list price
SCL-18DBL	18"	20" & 24"	3	\$56
SCL-22DBL	22"	24" & 30"	3	56

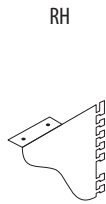
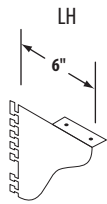

short –
supports rear of corner worksurface and guest side of peninsula worksurface

Model #	lbs	list price
SCL-6L	2	\$47
SCL-6R	2	47

left hand
right hand

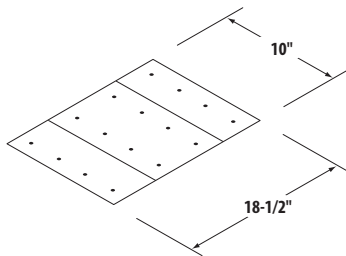

wood core clamp –
attaches two adjacent worksurfaces.
Medium grey.

Model #	lbs	list price
WC20	3	\$57

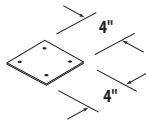

flat bracket –
attaches two adjacent worksurfaces –
primarily used as supplemental attachment to strengthen worksurface seams. Medium grey only.

Model #	lbs	list price
FB-1	0.5	\$8

countertop support

Countertop supports are used to center-mount countertops above Simon frames. Countertop supports are typically finished in the same coating color as the corresponding top cap. Mounting screws included. Countertop supports attach to all Simon panel frames except outer plexi and glass tile.

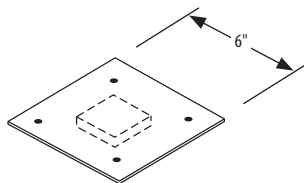

countertop support –
2 ea. recommended per panel

NOTE: Support posts will not mount directly above plexi or glass tiles.

Model #	lbs	list price
CTS-1	2	\$65



please specify:

- model number
- coating color

end panels

Unitized steel end panels are reversible for left- or right-hand attachment to worksurface with included mounting screws. End panels come with adjustable floor glides and are enamel finished.

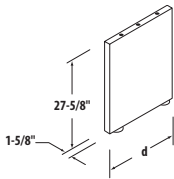

end panel

Model #	d	worksurface depth	lbs	list price
E20	18"	20"	18	\$300
E24	28	24"	28	348
E30	33	30"	33	423
E36	39	36"	39	517

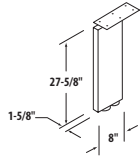

double end panel –

adjoins two worksurfaces or supports middle of longer worksurface

Model #	lbs	list price
E8	16	\$179

tube legs

Cylindrical steel tube legs attach to worksurface with included mounting screws. Tube legs come with adjustable floor glide(s) and are finished with a coating color.

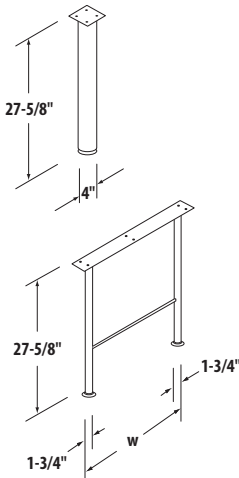

single tube leg –

attaches to unsupported end of any peninsula worksurface. May also be used to adjoin two worksurfaces or support rear end of corner worksurface.

Model #	lbs	list price
STL	8	\$161

double tube leg –

attaches to unsupported end of any worksurface.

Model #	w	lbs	list price
DTL20	20"	7	\$247
DTL24	24"	8	268
DTL30	30"	9	278

c-legs

Unitized steel c-legs attach to worksurface with included mounting screws. C-legs come with adjustable floor glides.

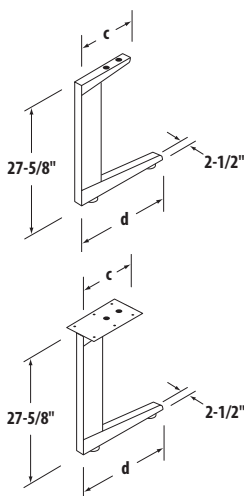

single c-leg

Model #	d	c	lbs	list price
C20	16-1/2"	16-1/2"	12	\$260
C24	22-1/2"	16-1/2"	13	302
C30	28-1/2"	22-1/2"	15	354

double c-leg –

adjoins two worksurfaces or supports middle of longer worksurface

Model #	d	c	lbs	list price
C20D	16-1/2"	16-1/2"	13	\$286
C24D	22-1/2"	16-1/2"	15	324
C30D	28-1/2"	22-1/2"	17	371



freestanding pedestals

please specify:

- model number
- coating color
- laminate ("LAM" option only)

see also:

- pedestal drawer options (*next page*)

freestanding pedestals

Freestanding pedestals come standard with cradle type, full suspension file drawers and enamel finish. Freestanding pedestals may be used alone, placed beneath 29" or higher worksurfaces or used to support worksurfaces. All pedestals come standard with lock.

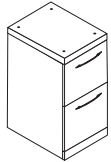

20" deep –
file/file

Model #	w	d	h	lbs	list price
20F	15"	18-1/2"	27-5/8"	54	\$780

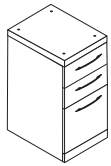

20" deep –
box/box/file

Model #	w	d	h	lbs	list price
20B	15"	18-1/2"	27-5/8"	57	\$780

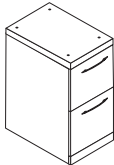

24" deep –
file/file

Model #	w	d	h	lbs	list price
24F	15"	23-1/2"	27-5/8"	66	\$841

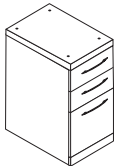

24" deep –
box/box/file

Model #	w	d	h	lbs	list price
24B	15"	23-1/2"	27-5/8"	69	\$841

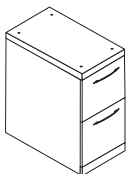

30" deep –
file/file

Model #	w	d	h	lbs	list price
30F	15"	28-3/4"	27-5/8"	82	\$972

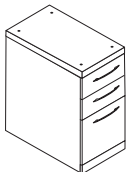

30" deep –
box/box/file

Model #	w	d	h	lbs	list price
30B	15"	28-3/4"	27-5/8"	86	\$972

NOTE: For finished top (no mounting holes) add "FT" to model number and add \$29 to list price.
(example: 24F-FT= \$870)

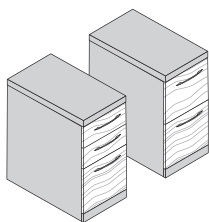

Optional Laminate Drawer Front –

Add "LAM" to model # and add \$361 to list price.
(example: 24F-LAM = \$1,202)



please specify:

- model number
- coating color
- fabric (ched)

see also:

- Chair Fabric Selection Guide

mobile pedestals

Mobile pedestals come standard with cradle type, full suspension file drawers and enamel finish. Mobile pedestals may be used alone or placed beneath 29" or higher worksurfaces. All pedestals come standard with lock.



24" deep –
file/file

Model #	w	d	h	lbs	list price
24FM	15"	23-1/2"	27-5/8"	66	\$735



24" deep –
box/box/file

Model #	w	d	h	lbs	list price
24BM	15"	23-1/2"	27-5/8"	69	\$735

mobile pedestal with seat cushion

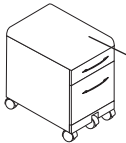

24" deep –
convenience/file
specify fabric
(see Chair Fabric Selection Guide)

Model #	w	d	h	lbs	list price
CHED	15"	23-1/2"	27-5/8"	55	\$750

pedestal drawer options & accessories

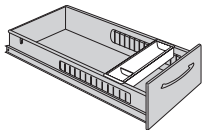

pencil tray –
supplied in black.

Model #	lbs	list price
PT-1	0.2	\$14

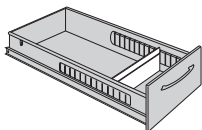

drawer divider –
supplied in medium grey.

Model #	lbs	list price
DD-1	0.2	\$7

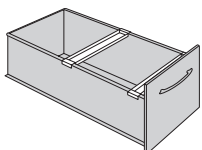

dual hanging crossbars –
converts letter to side-to-side legal; supplied in medium grey.

Model #	lbs	list price
F-HFB-C	1	\$39

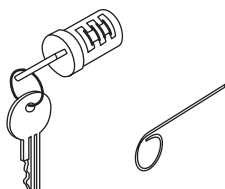

additional lock core & pick –
field installation only. Includes core, pick and two keys (keyed random or specify #)

Model #	lbs	list price
LC-1	4oz	\$39

additional key –
specify lock number when ordering.

Model #	lbs	list price
KO-F	2oz	\$24



2 drawer lateral file

please specify:

- model number
- coating color
- laminate ("LAM" option only)

see also:

- lateral file options (page 132)

2 drawer lateral file

2 drawer lateral files feature an interlock system which allows only one drawer to be opened at a time. Comes standard with front-to-back letter filing – option DHF (see below for other options). May be used alone, placed beneath 29" or higher worksurfaces or used to support worksurfaces.

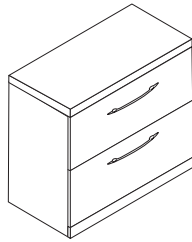

no lock

Model #	w	d	h	lbs	list price
S30-200	30"	18"	27-3/4"	115	\$898
S36-200	36"	18"	27-3/4"	128	950
S42-200	42"	18"	27-3/4"	141	1003

with lock

Model #	w	d	h	lbs	list price
S30-201	30"	18"	27-3/4"	118	\$935
S36-201	36"	18"	27-3/4"	131	990
S42-201	42"	18"	27-3/4"	144	1045

drawers

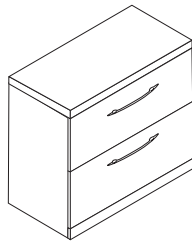

front-to-back letter filing standard –

For more drawer options refer to filing on page 132.

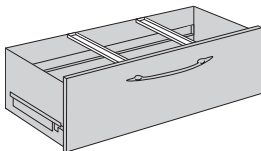

front-to-back letter filing standard –

For more drawer options refer to filing on page 132.

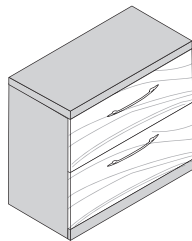

optional laminate drawer fronts –

Add "LAM" to model # and add \$355 to list price.

(example: S30-200 LAM = \$1160)



- model number
- coating color

personal locker

Simon personal lockers are heavy duty steel constructed and enamel finished. Lockers have standard high-sided drawers complete with steel wheel & ball bearing suspension. Base unit drawers and locker door come standard with locks.

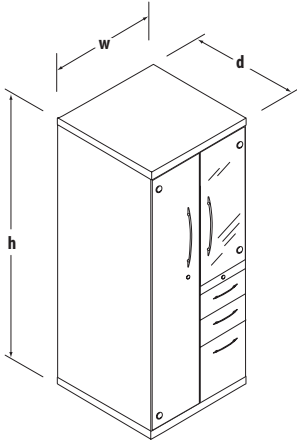

base unit features –

- locker with garment rod
- 2-box and 1-file drawer
- drawers and locker door with lock
- cabinet with frosted plexi door and binder-height inner shelf

Model #	w	d	h	lbs	list price
PL-24	23-13/16"	23-1/2"	50-3/16"	152	\$3078

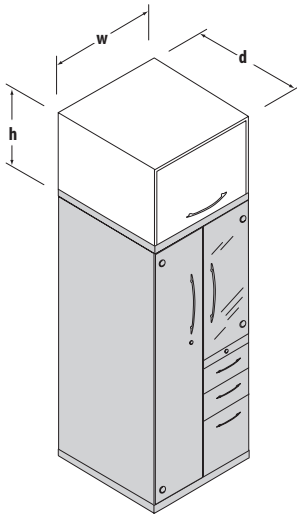

storage bin features –

- full depth storage with receding door
- stores laptop cases, large tote bags, briefcases, etc.
- arrives fully assembled to personal locker base unit

Model #	w	d	h	lbs	list price
PLSB-24	23-13/16"	23-1/2"	23-1/2"	36	\$780
PLSB-24L	23-13/16"	23-1/2"	23-1/2"	36	870

with lock

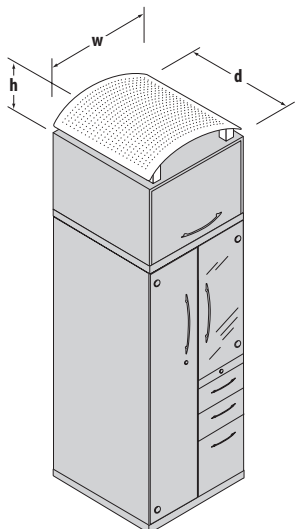

storage hood features –

- perforated steel arched storage hood
- stores blueprints, umbrellas, etc.
- attaches to storage bin or base unit
- arrives attached and fully assembled

Model #	w	d	h	lbs	list price
PLH-24	23-13/16"	23-1/2"	23-1/2"	8	\$495



panel mounted storage units

please specify:

- model number
- coating color
- laminate (*laminated storage bin*)

see also:

- task lights (*below*)

panel mounted storage units

Simon panel mounted storage units mount to corresponding Simon panels. Standard mounting height is 21" above the worksurface. Optional task lights can be added (*see below*).

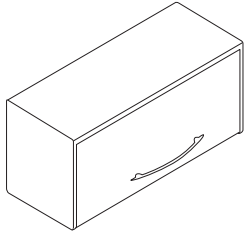

storage bin –

for optional receding door lock, add "L" to model number and add \$71 to list price. *Example: SB-54L = \$802*

Model #	w	d	h	lbs	list price
SB-24	23-3/4"	13-1/2"	13-3/4"	25	\$438
SB-30	29-3/4"	13-1/2"	13-3/4"	30	487
SB-36	35-3/4"	13-1/2"	13-3/4"	36	551
SB-42	41-3/4"	13-1/2"	13-3/4"	41	616
SB-48	47-3/4"	13-1/2"	13-3/4"	47	665
SB-54	53-3/4"	13-1/2"	13-3/4"	53	731

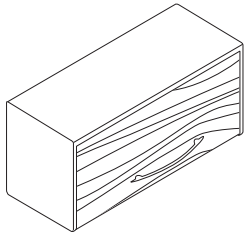

laminated door storage bin –

for optional receding door lock, add "L" to model number and add \$71 to list price. *Example: LSB-54L = \$1049*

Model #	w	d	h	lbs	list price
LSB-24	23-3/4"	13-1/2"	13-3/4"	25	\$586
LSB-30	29-3/4"	13-1/2"	13-3/4"	30	639
LSB-36	35-3/4"	13-1/2"	13-3/4"	36	736
LSB-42	41-3/4"	13-1/2"	13-3/4"	41	806
LSB-48	47-3/4"	13-1/2"	13-3/4"	47	878
LSB-54	53-3/4"	13-1/2"	13-3/4"	53	978

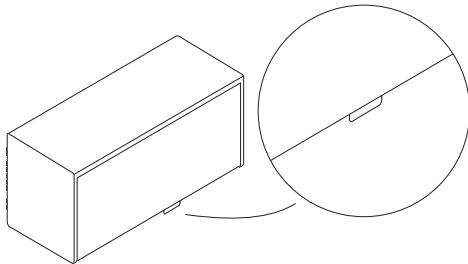

tab pull option –

no charge.
Specify on order: "recessed pulls"

storage unit task light

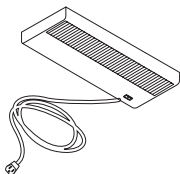

task light –

fits beneath overhead units and open shelves. LED task light features dimming 100% - 15%, 12 hour auto shut-off, 80+ color rendering index @ 3500k, and a 52,000 hour life span. Available in silver only.

model #	light width	lbs	list price
OTL-17	18-5/8"	4	\$264
OTL-31	32-5/8"	5	282
OTL-44	45-5/8"	6	298



- model number
- fabric (*acoustic tiles*)

• *Panel Fabric Selection Guide*

wall mounted frame and fasteners

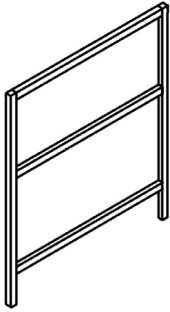

wall mounted frames –

mounts to wall using 1/4" fasteners. Comes in either full height 60" or 34" (*overhead + tile*) height.

model #	w	h	description	lbs	list price
WMF-24	24"	34"	overhead unit + 21" tile		\$203
WMF-30	30"	34"	overhead unit + 21" tile		203
WMF-36	36"	34"	overhead unit + 21" tile		203
WMF-42	42"	34"	overhead unit + 21" tile		203
WMF-48	48"	34"	overhead unit + 21" tile		203
WMF-54	54"	34"	overhead unit + 21" tile		203

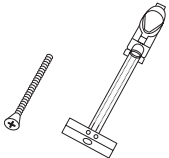

wall mounted frame fasteners (toggles) –

mount wall hanger strips to standard dry-wall. Order one per foot or four per wall hanger strip.

Model #	lbs	list price
WKF-1	.05	\$8

wall mounted units

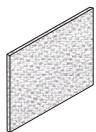

tackboard – sound dampening tackboard specially designed to mount to wall strip (shown above).

Model #	w	h	description	lbs	list price
TBW-2124	24"	21"	24" wide wall mount	7	\$180
TBW-2130	30"	21"	30" wide wall mount	9	203
TBW-2136	36"	21"	36" wide wall mount	11	261
TBW-2142	42"	21"	42" wide wall mount	13	304
TBW-2148	48"	21"	48" wide wall mount	15	334
TBW-2154	54"	21"	54" wide wall mount	17	372



please specify:
• model number

see also:
• frames ordered separately (page 18)

super acoustic frame pillows

Couple with Simon super acoustic tiles to achieve a .95 NRC (Noise Reduction Coefficient). Remnant fabrics are used for cost efficiency.

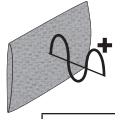

tile height	lbs	20" w	24" w	30" w	36" w	42" w	48" w	54" w
7" = 1	.25	P-0720 = \$49	P-0724 = \$49	P-0730 = \$49	P-0736 = \$71	P-0742 = \$71	P-0748 = \$71	P-0754 = \$91
14" = 2	.75	P-1420 = \$71	P-1424 = \$71	P-1430 = \$71	P-1436 = \$91	P-1442 = \$91	P-1448 = \$91	P-1454 = \$113
21" = 3	1.25	P-2120 = \$91	P-2124 = \$91	P-2130 = \$91	P-2136 = \$113	P-2142 = \$113	P-2148 = \$113	P-2154 = \$133
28" = 4	1.75	P-2820 = \$123	P-2824 = \$123	P-2830 = \$123	P-2836 = \$134	P-2842 = \$134	P-2848 = \$134	P-2854 = \$176
35" = 5	2.25	P-3520 = \$151	P-3524 = \$151	P-3530 = \$151	P-3536 = \$151	P-3542 = \$176	P-3548 = \$176	P-3554 = \$208

pillow specification

- step 1: determine frame crossmember - (see page 18)
- step 2: determine pillow position - (see below)
- step 3: determine number of shared panels - one pillow per two tiles
- step 4: determine number of unshared panels (one pillow per super-acoustic tile)
- step 5: specify pillow - (see chart above)

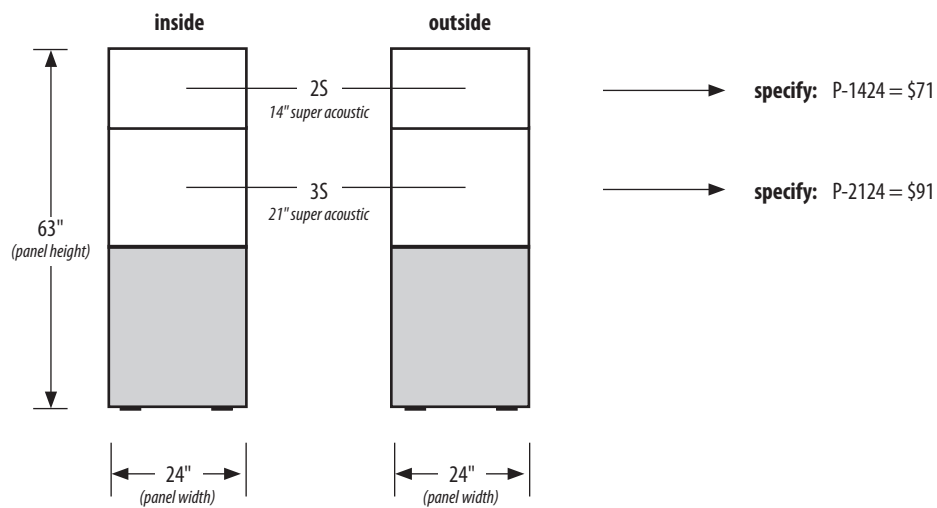

panel weights (lbs.)

Use the size chart below to determine complete panel weight.

panel height	panel width						
	20"	24"	30"	36"	42"	48"	54"
35"	26	31	37	44	49	57	62
42"	30	39	44	49	59	64	73
49"	34	42	49	57	66	73	83
56"	38	46	57	67	77	87	97
63"	42	53	63	75	85	93	106
70"	47	59	69	83	93	106	116
77"	52	64	76	90	102	114	126
84"	57	70	82	96	110	123	137
91"	62	73	87	103	117	133	147
98"	67	79	94	110	124	142	156
105"	72	84	98	118	132	151	165

example: S6354-5F4A-D = 106 lbs.

panel weight notes

- For no tile "N" – subtract the corresponding tile weight from the panel. See individual tile weight chart (see below).
- Window tiles do not effect the weight of panel.
- For storage bin "B" – subtract per side specified the following:

storage bin width						
20"	24"	30"	36"	42"	48"	54"
3	4	5	6	7	7	8

example: S6354-3F3A2B-5F4A = 98 lbs. (106 - 8)

individual tile weights (lbs.)

Use the size chart below to determine individual tile weight.

tile height	tile width						
	20"	24"	30"	36"	42"	48"	54"
1 = 7"	2	2	2	3	4	4	4
2 = 14"	3	4	5	6	7	7	8
3 = 21"	5	6	7	8	10	11	13
4 = 28"	5	7	9	11	13	15	17
5 = 35"	7	9	11	14	16	19	21

example: T-1454F = 8 lbs.

example: T-2848AVM = 15 lbs.

individual frame weights (lbs.)

Use the size chart below to determine individual frame weight.

frame height	frame width						
	20"	24"	30"	36"	42"	48"	54"
35"	12	13	15	16	17	19	20
42"	14	15	16	17	19	20	21
49"	15	16	17	19	20	21	23
56"	17	18	21	23	25	27	29
63"	19	21	23	25	27	29	30
70"	21	23	25	27	29	30	32
77"	22	24	26	28	30	32	34
84"	24	26	28	30	32	33	35
91"	25	27	29	31	33	35	37
98"	27	29	30	32	34	36	38
105"	29	30	32	34	36	37	39

example: F-8430 = 35 lbs.



e-lift legs

e-lift legs attach to worksurface with included mounting screws. e-lift legs come with adjustable floor glides, and adjustable height range from 24H - 50H. Coatings are limited. *Includes simple two button control.*

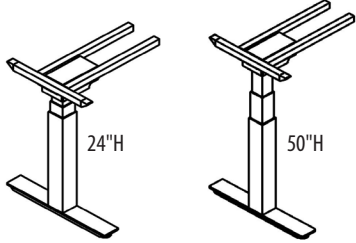

e-lift leg - left hand

model #	d	h	list price
2L2M	20", 24" & 30"	24" - 50"	\$974
3L3M	20", 24" & 30"	24" - 50"	1461

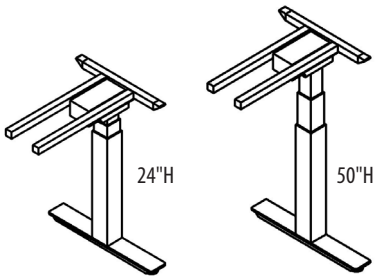

e-lift leg - right hand

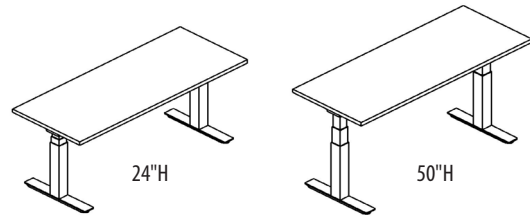

2L2M - 2-leg / 2 motor

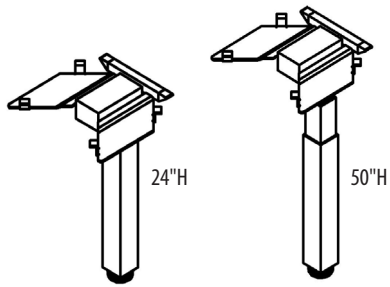

e-lift leg - for I-shape desks

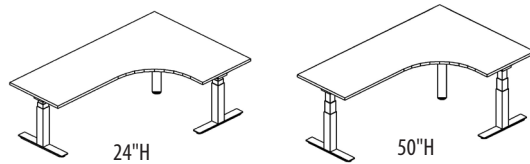

3L3M - 3-leg / 3 motor

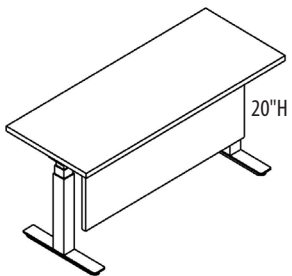

modesty shield option –

For optional 20"H modesty shield. List price is \$220. Dimension will be determined by factory. Model # MS-XX. Example: MS-48





SUZU FREESTANDING
DESK
SYSTEM

Consumer Price List #38 – Effective January 1, 2022



SUZU

FREESTANDING
DESK
SYSTEM

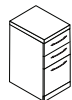
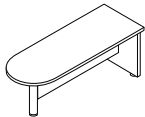
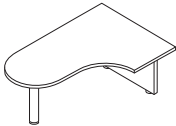
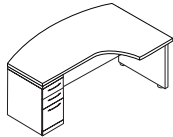
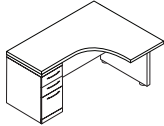
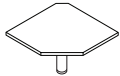
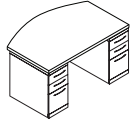
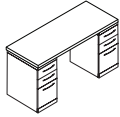

product overview page 78

specification guide page 80

rectangular units page 82

bow top units page 85

corner units page 86

“L” shaped units page 88

“L” bow shaped units & hockey stick units page 90

“L” shaped peninsula units page 92

peninsula units page 94

support components

end panels page 96

tube legs page 96

c-legs page 97

wood core clamp page 97

freestanding pedestals page 98

mobile pedestals page 99

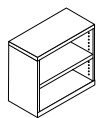

under-top bookcases page 100

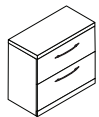

2-drawer laterals page 101

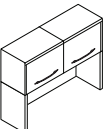

hutches page 102

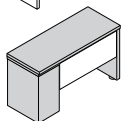

modesty panels page 103

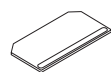

keyboards page 104

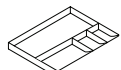

accessories page 105

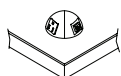

scallops & grommets page 106

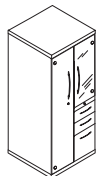

personal locker page 108

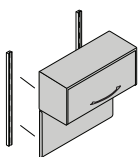

wall mounted units and storage components page 109



tackboards page 109

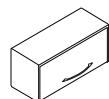

storage bins and open shelves page 110



task lights page 110

SUZU

FREESTANDING
DESK
SYSTEM

As a desk system, **Suzu Freestanding Modular System** from McDowell-Craig is out-of-this-world. No mere office mortal, Suzu isn't hurt by heavy usage. Steel-construction makes her an office super-hero that will serve as the basic building block of your office for years to come. Suzu intermembers seamlessly with her brother Simon... McDowell-Craig's state of the art frame and tile system.

features and benefits

support components

Pedestals, end panels, tube legs and the like are interchangeable – both functionally and dimensionally. Field changes (right to left) are quick and simple.

super grade-A construction

McDowell-Craig's 70+ year reputation for quality is built into every Suzu component – ideal for all customers.

standard equipment tops

Suzu tops have the same dimensions as Simon tops and are available in a wide variety of edges and shapes.

modesty panels

Three heights and numerous widths accommodate every freestanding need.

steel end panel

Factory assembled to Suzu tops, these heavy steel constructed end panels are the foundation of the Suzu system. Standard with adjustable glides that allow for slide-in under-worksurface storage, these panels come in 8" connector and full width varieties.

c-legs

Suzu c-legs leave an open area below the worksurface while providing maximum top support. Like the steel end panels, c-legs come standard with adjustable floor glides that accommodate slide-in under-worksurface storage.

under-worksurface storage

McDowell-Craig's 70+ year reputation for quality has always been spear-headed by the highest quality storage and filing available. This reputation for quality is clearly seen in the Suzu pedestals, bookcases and lateral files. Built to last a lifetime, these products are engineered to remain square, and in excellent working condition for decades. All filing can be used either as top support or slide-in options.

hutches

Hutches mount on desks, returns or credenzas. Easily added to existing product both Suzu or Legacy. Size ranges: 36" w - 84" w. Steel constructed and bolt secured to tops, Suzu hutches are engineered for high use and flawless function. These beautifully constructed hutches come standard with brushed metal pulls and a tackboard. Suzu hutches are fully finished for open floor plans and accommodate optional under-storage task lights.

keyboards and accessories

Keyboard arms and platforms facilitate correct ergonomic configurations and are completely compatible with Suzu configurations. Optional CPU holders and pencil drawers are excellent for organizing desktop clutter and keeping work-flow efficient.

environmentally friendly

Suzu filing units, hutches and support components are constructed of heavy gauge domestic steel and are 100% recyclable. Every pound of steel scrap used in fabricating Suzu is recycled.



finishes

coatings

Standard Coatings — Suzy filing units, hutches and support components are available in a variety of coatings.
See *McDowell-Craig Selection Guide*.

Special Coatings — Suzy filing units, hutches and support components may be ordered in factory approved special coatings — add 8% to price of unit + \$1170 set-up and mixing charge per color per order.
NOTE: written factory approval must accompany your purchase order.

laminates

Standard Laminates — A variety of laminate patterns, solids, textures, metallic and wood grains are available.
See *McDowell-Craig Plastic Laminates Selection Guide* for standard selections.

Special Laminates — Suzy worksurfaces may also be ordered with factory approved special laminates — add 8% to price of unit + \$722 per pattern per order. **NOTE:** written factory approval must accompany your purchase order.

fabrics

All fabric prices for hutch tackboards are based on Grade I fabrics. See *McDowell-Craig Fabric Selection Guide*.
For other Grade I fabrics add 8% to price of unit (e.g. tile, tackboard) + \$197 per fabric.

step-by-step

- 1) **top** - determine top shape, edge and dimensions
- 2) **top support** - select support options for both left and right side of top
- 3) **modesty panel** - select a modesty panel option
- 4) **model number and pricing** - use the selected components to build the final model number and determine pricing
- 5) **description** - top size + support + handing or double = description

step 1 – select a top

determine shape, edge type and size

rectangular (page 83)	corner (page 87)	"L" shaped (page 89)	peninsula (page 95)
--------------------------	---------------------	-------------------------	------------------------

___-4224	42"	
___-4824	48"	1
___-5424	54"	21
___-6024	60"	22
___-6624	66"	265
___-7224		

top and edge

60w x 24d rectangular top with banded edge (page 83)

B - 6 0 2 4

edge type (banded) dimensions (60"w x 24"d)

left-hand support

end panel (page 96)

E 2 4

right-hand support

pedestal with 2-box and 1-file drawer (page 98)

2 4 B

modesty panel

short modesty (page 103)

S M

step 2 – top support

determine top support for both sides

c-legs page 97	end panels page 96	pedestal page 98	lateral page 101	bookcase page 100	clamp page 97	tube legs page 96
-------------------	-----------------------	---------------------	---------------------	----------------------	------------------	----------------------

left side			right side	
model #	d	worksurface depth	model #	w
E20	18"	20"		15"
E24	23"	24"	24B	
E28	28"			

top and edge

60w x 24d rectangular top with banded edge (page 83)

B - 6 0 2 4

left-hand support

end panel (page 96)

E 2 4

full end panel 24" deep

right-hand support

pedestal with 2-box and 1-file drawer (page 98)

2 4 B

24" deep pedestal 2-box/1-file drawer

modesty panel

short modesty (page 103)

S M



step 3 – modesty panel

select a modesty panel option

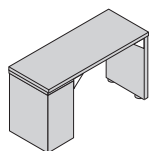

no modesty panel
"NM"

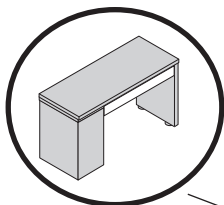

short modesty panel
"SM"

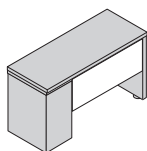

3/4 modesty panel
"3M"

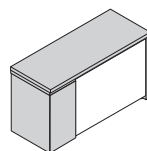

full modesty panel
"FM"

for 6" inset add "I" as suffix to any modesty panel

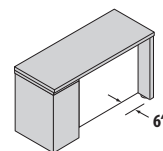

inset modesty panel
"I"

top and edge
60w x 24d rectangular top with banded edge
(page 83)
B - 6 0 2 4

left-hand support
end panel
(page 96)
E 2 4

right-hand support
pedestal with 2-box and 1-file drawer
(page 98)
2 4 B

modesty panel
short modesty
(page 103)
S M

short modesty panel

SUZY freestanding desk

step 4 – model number and pricing

use the selected components to build the final model number and determine pricing

top and edge type	left hand support	right hand support	modesty panel	
B-6024	E24	24B	SM	B-6024 E24 24B SM
\$435	\$348	\$841	\$81	\$1705

step 5 – description

top size + support + handing or double = description

model number		description	
B-6024 E24 24B SM	→	60"x 24" Desk Ped RH	(single ped example)
B-6030 30B 30F FM	→	60" x 30" Desk Double Ped	(double ped example)
B-4824 E24 WC20	→	48" x 24" Return EP LH	(LH return example)
B-6024 C24 C24	→	60" x 24" Table	(table example)



please specify:

- edge color
- laminate
- coating

see also:

- specification guide (page 80)
- Edge Selection Guide
- scallop & grommet selection guide (page 106)

rectangular tops

Rectangular tops are supported by support components (see below). Available in Banded-edge. For a list of available edge colors, please refer to Edge Selection Guide.

Rectangular tops support optional scallops where no modesty panel is used. For scallop & grommet options, see page 106.

top support components:

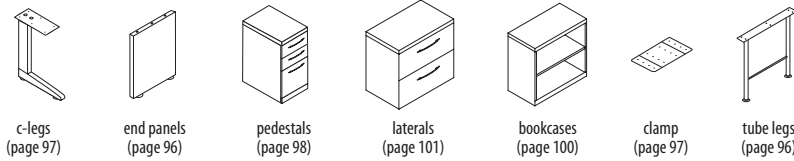

woodgrain direction:

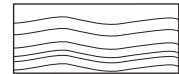

modesty panel options:

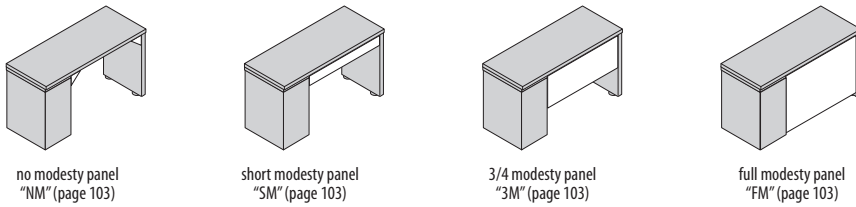

configuration examples:

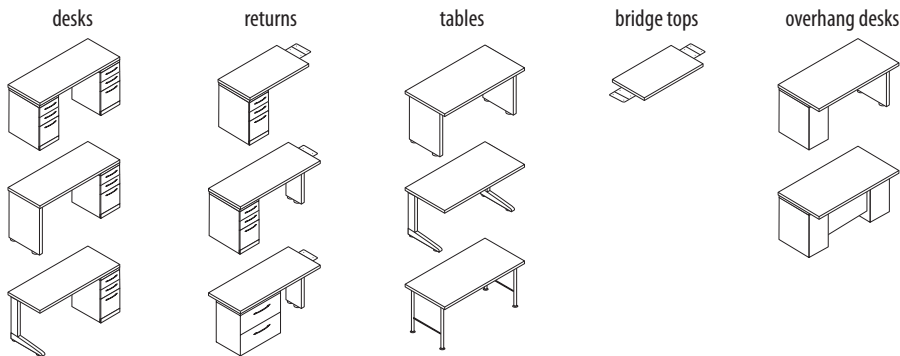

specification example:

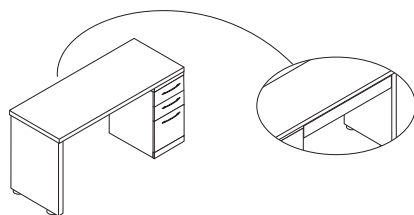

example: B-6024-E24-24B-SM = \$1694

top and edge	left-hand support	right-hand support	modesty panel	price
60w x 24d rectangular top with banded edge (opposite page)	end panel (page 96)	pedestal with 2-box and 1-file drawer (page 98)	short modesty (page 103)	
\$424	\$348	\$841	\$81	
B - 6 0 2 4	E 2 4	2 4 B	S M	\$1694



20" deep rectangular

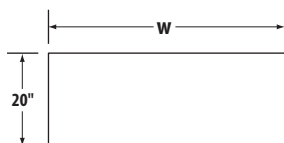

model #	w	lbs	list price
			"B" (banded)
B-2420	24"	16	\$220
B-3020	30"	20	249
B-3620	36"	24	256
B-4220	42"	28	318
B-4820	48"	32	333
B-5420	54"	36	355
B-6020	60"	40	372
B-6620	66"	44	470
B-7220	72"	48	485
B-7820	78"	52	613
B-8420	84"	55	634
B-9020	90"	59	650
B-9620	96"	63	667

24" deep rectangular

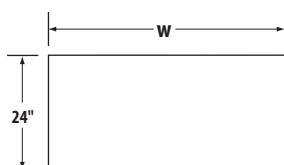

model #	w	lbs	"B" (banded)
B-2424	24"	19	\$227
B-3024	30"	24	266
B-3624	36"	29	311
B-4224	42"	34	325
B-4824	48"	39	341
B-5424	54"	43	410
B-6024	60"	48	424
B-6624	66"	52	485
B-7224	72"	57	507
B-7824	78"	62	629
B-8424	84"	67	644
B-9024	90"	71	675
B-9624	96"	76	688

30" deep rectangular

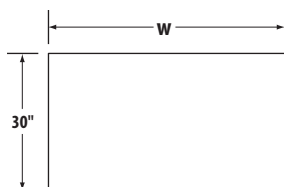

model #	w	lbs	"B" (banded)
B-2430	24"	24	\$264
B-3030	30"	30	311
B-3630	36"	36	341
B-4230	42"	42	439
B-4830	48"	48	454
B-5430	54"	54	470
B-6030	60"	60	492
B-6630	66"	66	596
B-7230	72"	72	629
B-7830	78"	78	644
B-8430	84"	84	660
B-9030	90"	89	780
B-9630	96"	95	811

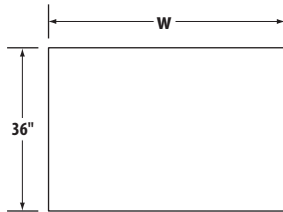
36" deep rectangular

<i>model #</i>	<i>w</i>	<i>lbs</i>	list price
			<i>"B" (banded)</i>
B-4836	48"	57	\$559
B-5436	54"	64	613
B-6036	60"	71	667
B-6636	66"	78	734
B-7236	72"	85	796
B-7836	78"	92	854
B-8436	84"	100	916
B-9036	90"	107	969
B-9636	96"	115	1052

please specify:

- edge color
- laminate
- coating

see also:

- specification guide (page 80)
- Edge Selection Guide
- scallop & grommet selection guide (page 106)

bow tops

Bow tops are supported by support components (see below). Available in Banded-edge. For a list of available edge colors, please refer to Edge Selection Guide. Modesty panels inset on all desk configurations.

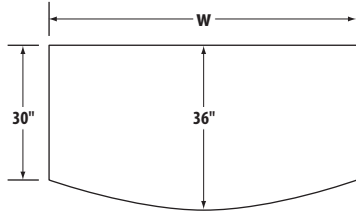

36" deep bow

model #	w	lbs	list price
			"B" (banded)
BB-6636	66"	73	\$854
BB-7236	72"	77	916
BB-7836	78"	85	940
BB-8436	84"	91	1005
BB-9036	90"	97	1087

top support components:

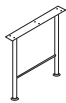

tube legs (page 96)

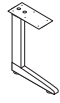

c-legs (page 97)

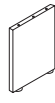

end panels (page 96)



pedestals (page 98)

woodgrain direction:

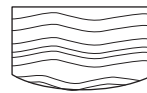

modesty panel options:

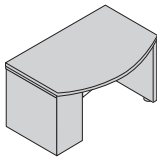

no modesty panel "NM" (page 103)

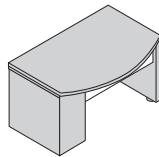

short modesty panel "SM" (page 103)

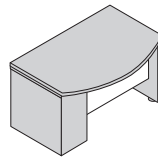

3/4 modesty panel "3M" (page 103)

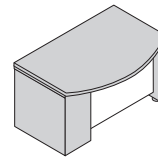

full modesty panel "FM" (page 103)

configuration examples:

desks

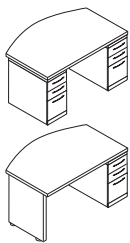

tables

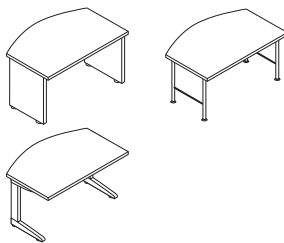

specification example:

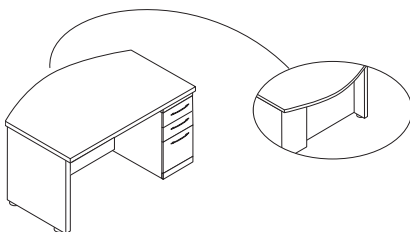

example: BB-7236-E30-30B-FM-I = \$2460

top and edge

72w x 36d bow top with banded edge (above)

\$916

B B - 7 2 3 6

left-hand support

end panel (page 96)

\$423

E 3 0

right-hand support

pedestal with 2-box and 1-file drawer (page 98)

\$954

3 0 B

modesty panel

full modesty – inset (page 103)

\$175

F M

price

\$2460



corner units

please specify:

- edge color
- laminate
- coating

see also:

- specification guide (page 80)
- Edge Selection Guide
- scallop & grommet selection guide (page 106)

corner tops

Corner tops are supported by support components (see below). Available in Banded-edge. For a list of available edge colors, please refer to *Edge Selection Guide*.

Corner tops support optional scallops. For scallop & grommet options, see page 106.

top support components:

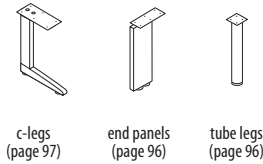

woodgrain direction:

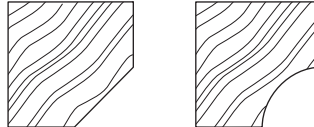

supported corner configuration example:

supported corners must be used with single support leg and freestanding components on both sides (see example).

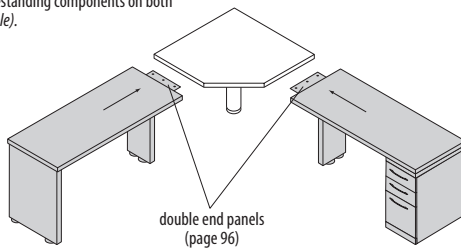

freestanding corner configuration example:

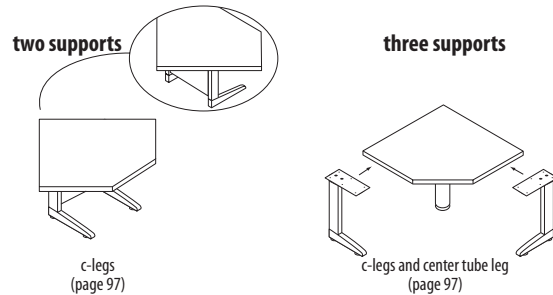

supported corner specification example:

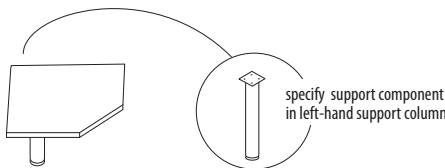

example: CB-3624 SL = \$676

top and edge	center support	price
36w x 24d corner top with banded edge <i>(opposite page)</i>	single support leg <i>(page 96)</i>	
\$559	\$161	
C B - 3 6 2 4	S T L	\$717

freestanding corner specification example:

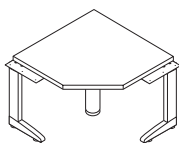

example: CB-3624-C24D-C24D-STL = \$1368

top and edge	left-hand support	right-hand support	center support/modesty	price
36w x 24d corner top with banded edge <i>(opposite page)</i>	24" double c-leg <i>(page 97)</i>	24" double c-leg <i>(page 97)</i>	single support leg <i>(page 96)</i>	
\$559	\$324	\$324	\$161	
C B - 3 6 2 4	C 2 4 D	C 2 4 D	S T L	\$1368



basic

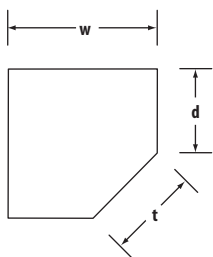

20" deep
basic corner

24" deep
basic corner

30" deep
basic corner

					list price
model #	w	d	t	lbs	"B" (banded)
CB-3620	36"	20"	23"	38	\$530
CB-4220	42"	20"	31"	50	681
CB-3624	36"	24"	17"	40	559
CB-4224	42"	24"	25"	52	696
CB-4824	48"	24"	34"	66	780
CB-4230	42"	30"	17"	55	720
CB-4830	48"	30"	25"	71	797

radius

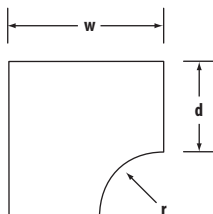

20" deep
radius corner

24" deep
radius corner

30" deep
radius corner

					list price
model #	w	d	r	lbs	"B" (banded)
RCB-3620	36"	20"	16"	36	\$558
RCB-4220	42"	20"	18"	47	699
RCB-3624	36"	24"	12"	37	574
RCB-4224	42"	24"	18"	48	713
RCB-4824	48"	24"	18"	62	787
RCB-4230	42"	30"	12"	52	729
RCB-4830	48"	30"	18"	67	801

radius transition

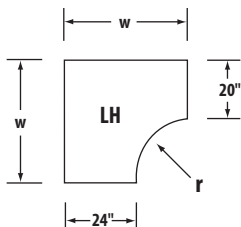

20"-24" deep
radius transition
corner

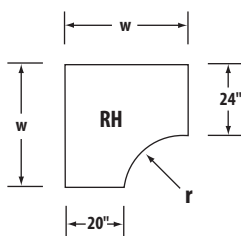

					list price
left hand	right hand	w	r	lbs	"B" (banded)
NCB-362024L	NCB-362024R	36"	14"	37	\$622
NCB-422024L	NCB-422024R	42"	18"	48	765
NCB-482024L	NCB-482024R	48"	18"	62	840

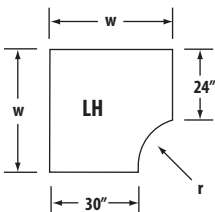

24"-30" deep
radius transition
corner

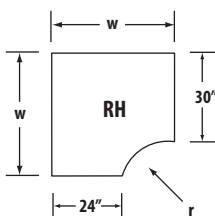

					list price
left hand	right hand	w	r	lbs	"B" (banded)
NCB-422430L	NCB-422430R	42"	16"	52	\$797
NCB-482430L	NCB-482430R	48"	18"	67	878

SUZY
freestanding desk



"L" shaped units

please specify:

- edge color
- laminate
- coating

see also:

- specification guide (page 80)
- Edge Selection Guide
- scallop & grommet selection guide (page 106)

"L" shaped tops

"L" shaped tops are supported by support components (see below). Available in Banded-edge. For a list of available edge colors, please refer to Edge Selection Guide.

"L" shaped tops support optional scallops where no modesty panel is used. For scallop & grommet options, see page 106.

top support components:

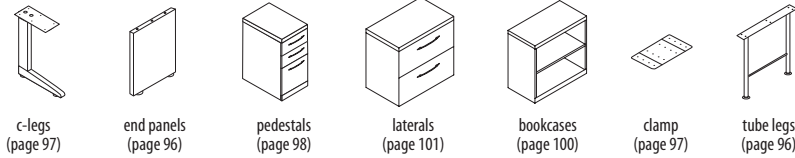

woodgrain direction:

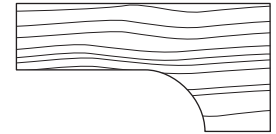

modesty panel options:

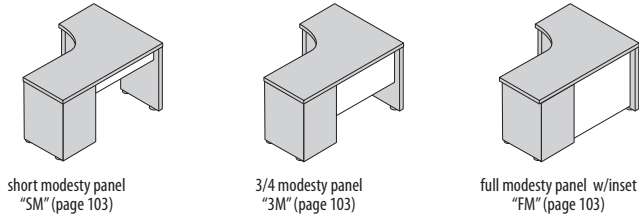

configuration examples:

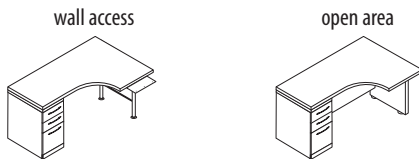

specification example:

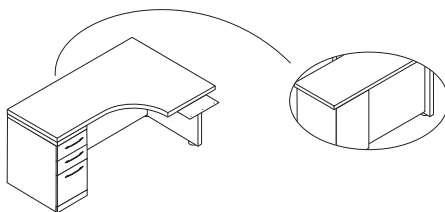

example: LB-724824L-24B-C24-E8-NM = \$2695

top and edge	left-hand support	right-hand support	modesty panel	price
72w x 48d "L" shaped radius top with banded edge (opposite page)	pedestal with 2-box and 1-file drawer (page 98)	end panel (page 96)	full modesty (page 103)	
\$1158	\$841	\$517	\$179	
L B - 7 2 4 8 2 4 L	2 4 B	E 3 6	F M	\$2695



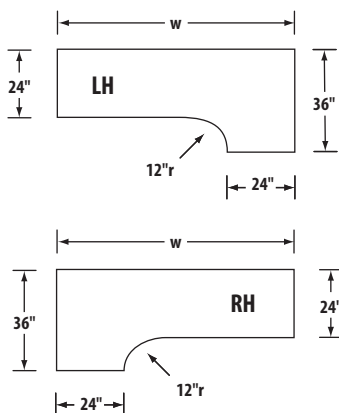

36" "L" shaped radius top

left hand		right hand		list price	
model #	model #	w	lbs	"B" (banded)	
LB-603624L	LB-603624R	60"	63	\$734	
LB-663624L	LB-663624R	66"	67	825	
LB-723624L	LB-723624R	72"	72	878	
LB-783624L	LB-783624R	78"	75	986	
LB-843624L	LB-843624R	84"	78	1067	
LB-903624L	LB-903624R	90"	82	1127	

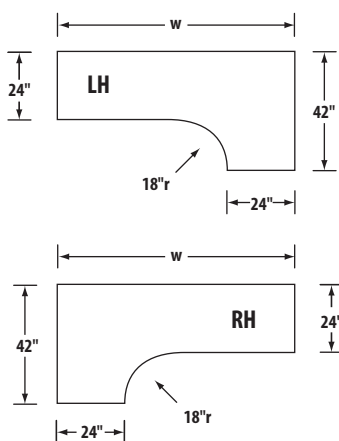

42" "L" shaped radius top

left hand		right hand		list price	
model #	model #	w	lbs	"B" (banded)	
LB-604224L	LB-604224R	60"	65	\$954	
LB-664224L	LB-664224R	66"	69	1075	
LB-724224L	LB-724224R	72"	73	1090	
LB-784224L	LB-784224R	78"	77	1114	
LB-844224L	LB-844224R	84"	80	1158	
LB-904224L	LB-904224R	90"	84	1209	

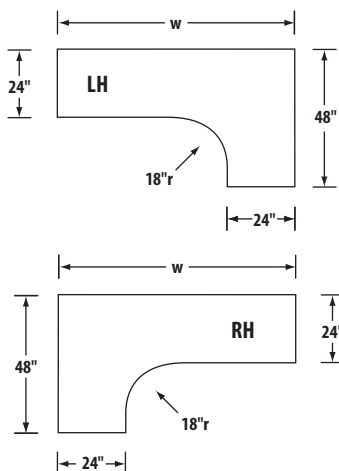

48" "L" shaped radius top

left hand		right hand		list price	
model #	model #	w	lbs	"B" (banded)	
LB-604824L	LB-604824R	60"	69	\$1036	
LB-664824L	LB-664824R	66"	73	1127	
LB-724824L	LB-724824R	72"	77	1158	
LB-784824L	LB-784824R	78"	81	1197	
LB-844824L	LB-844824R	84"	84	1224	
LB-904824L	LB-904824R	90"	88	1222	
LB-964824L	LB-964824R	96"	92	1297	

SUZY
freestanding desk



"L" Bow Shaped Units & Hockey Stick Units

please specify:

- edge color
- laminate
- coating

see also:

- specification guide (page 80)
- Edge Selection Guide
- scallop & grommet selection guide (page 106)

"L" bow shaped tops

"L" bow shaped tops are supported by support components (see below). Available in Banded-edge. For a list of available edge colors, please refer to *Edge Selection Guide*.

"L" bow shaped tops support optional scallops where no modesty panel is used. For scallop & grommet options, see page 106.

top support components:

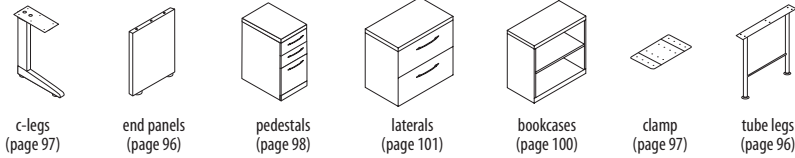

woodgrain direction:

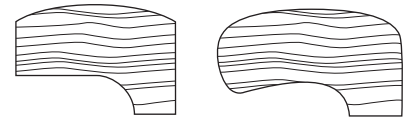

modesty panel options:

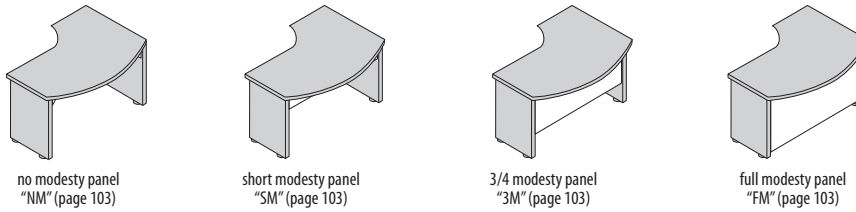

configuration examples:

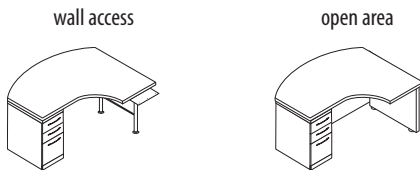

specification example:

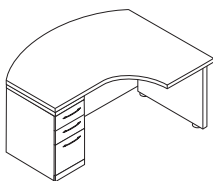

example: LBB-724224L-30B-E36-FM = \$2909

top and edge	left-hand support	right-hand support	modesty panel	price
72w x 36d boot shaped radius top with banded edge (opposite page)	pedestal with 2-box and 1-file drawer (page 98)	end panel (page 96)	full modesty (page 103)	
\$1241	\$972	\$517	\$179	
L B B - 7 2 4 2 2 4 L	3 0 B	E 3 6	F M	\$2909



"L" bow shaped unit

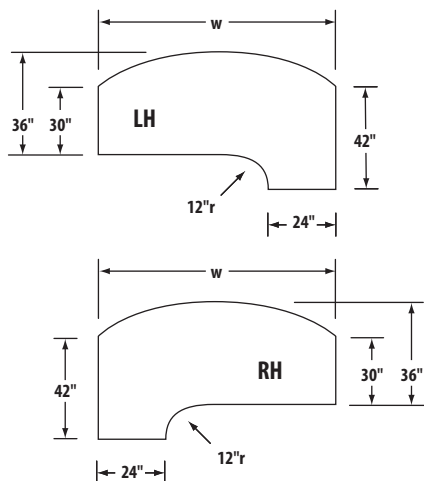

left hand		right hand		list price	
model #	model #	w	lbs	"B" (banded)	
LBB-724224L	LBB-724224R	72"	77	\$1241	
LBB-784224L	LBB-784224R	78"	81	1266	
LBB-844224L	LBB-844224R	84"	84	1310	
LBB-904224L	LBB-904224R	90"	88	1361	

hockey stick unit

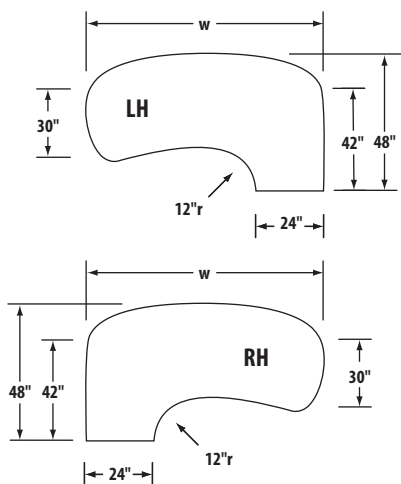

left hand		right hand		list price	
model #	model #	w	lbs	"B" (banded)	
HSB-724224L	HSB-724224R	72"	77	\$1241	
HSB-784224L	HSB-784224R	78"	81	1266	
HSB-844224L	HSB-844224R	84"	84	1309	
HSB-904224L	HSB-904224R	90"	88	1361	



"L" shaped peninsula units

please specify:

- edge color
- laminate
- coating

see also:

- specification guide (page 80)
- Edge Selection Guide
- scallop & grommet selection guide (page 106)

"L" shaped peninsula tops

"L" shaped peninsula tops are supported by support components (see below). Available in Banded-edge. For a list of available edge colors, please refer to *Edge Selection Guide*.

"L" shaped peninsula tops support optional scallops where no modesty panel is used. For scallop & grommet options, see page 106.

top support components:

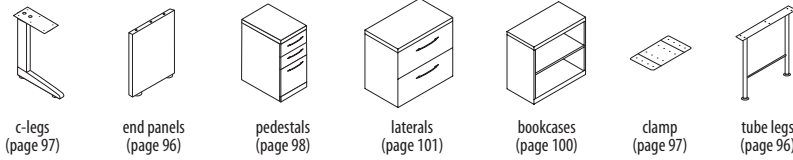

woodgrain direction:

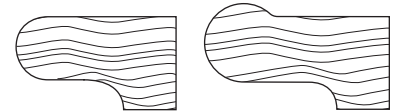

modesty panel options:

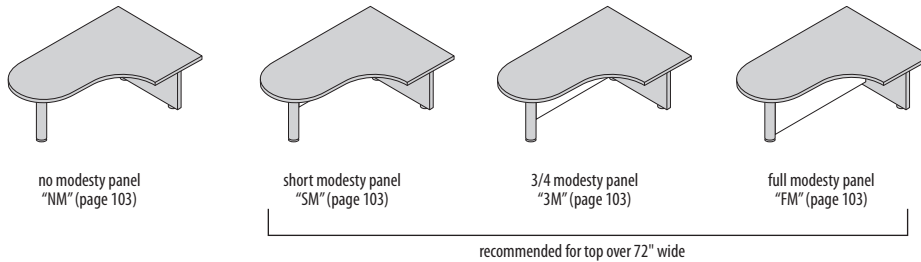

configuration examples:

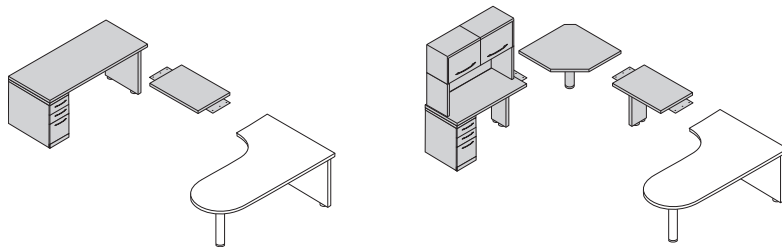

specification example:

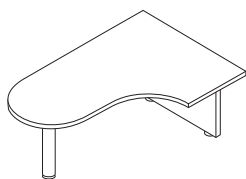

example: LPB-722430L-STL-E36-NM = \$1734

top and edge

72w x 30d basic peninsula top with banded edge (opposite page)

\$1016

L P B - 7 2 4 2 3 0 L

left-hand support

tube leg (page 96)

\$161

S T L

right-hand support

end panel (page 96)

\$517

E 3 6

modesty panel

no modesty (page 103)

\$70

N M

price

\$1734



42" deep "L" shaped

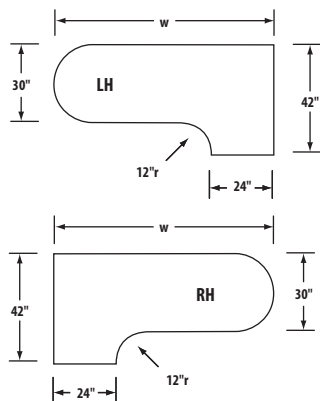

left hand		right hand		list price	
model #	model #	w	lbs	"B" (banded)	
LPB-724230L	LPB-724230R	72"	72	\$1016	
LPB-784230L	LPB-784230R	78"	78	1285	
LPB-844230L	LPB-844230R	84"	84	1332	
LPB-904230L	LPB-904230R	90"	90	1400	

42" deep "L" shaped peninsula

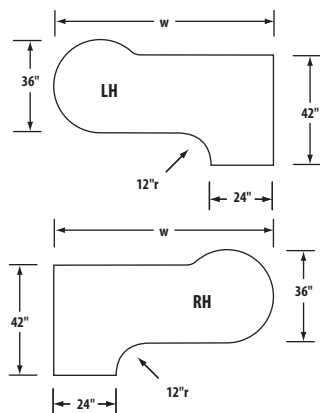

left hand		right hand		list price	
model #	model #	w	lbs	"B" (banded)	
LPPB-724230L	LPPB-724230R	72"	72	\$1052	
LPPB-784230L	LPPB-784230R	78"	78	1316	
LPPB-844230L	LPPB-844230R	84"	84	1371	
LPPB-904230L	LPPB-904230R	90"	90	1378	



peninsula units

please specify:

- edge color
- laminate
- coating

see also:

- specification guide (page 80)
- *Edge Selection Guide*
- scallop & grommet selection guide (page 106)

peninsula tops

Peninsula tops are supported by support components (see below). Available in Banded-edge. For a list of available edge colors, please refer to *Edge Selection Guide*.

Peninsula units support optional scallops where no modesty panel is used. For scallop & grommet options, see page 106.

top support components:

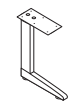

c-legs (page 97)



end panels (page 96)



pedestals (page 98)

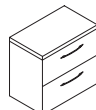

laterals (page 101)

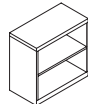

bookcases (page 100)



clamp (page 97)

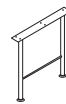

tube legs (page 96)

woodgrain direction:

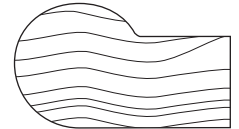
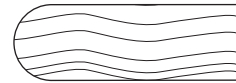

modesty panel options:

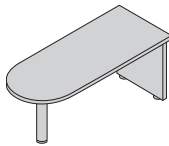

no modesty panel "NM" (page 103)

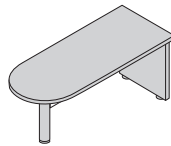

short modesty panel "SM" (page 103)

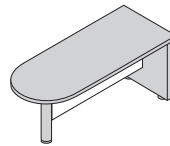

3/4 modesty panel "3M" (page 103)

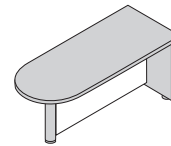

full modesty panel "FM" (page 103)

recommended for top over 72" wide

configuration examples:

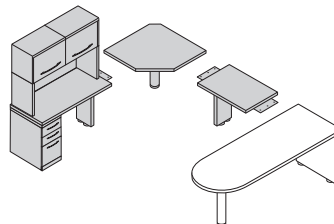
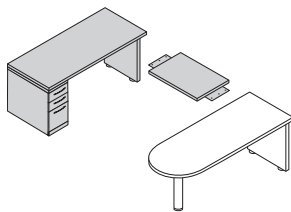

specification example:

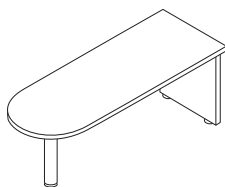

example: PB-7230-STL-E30-NM = \$1387

top and edge	left-hand support	right-hand support	modesty panel	price
72w x 30d basic peninsula top with banded edge (opposite page)	tube leg (page 96)	end panel (page 96)	no modesty (page 103)	
\$734	\$161	\$423	\$40	
P B - 7 2 3 0	S T L	E 3 0	N M	\$1387



30" basic peninsula

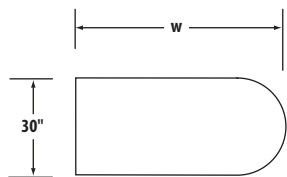

model #	w	lbs	list price
			"B" (banded)
PB-4830	48"	45	\$522
PB-5430	54"	51	559
PB-6030	60"	57	576
PB-6630	66"	63	681
PB-7230	72"	69	734
PB-7830	78"	75	751
PB-8430	84"	81	765
PB-9030	90"	86	854
PB-9630	96"	92	924

36" basic peninsula

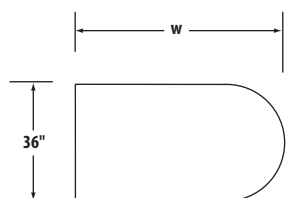

PB-4836	48"	53	\$634
PB-5436	54"	60	696
PB-6036	60"	68	734
PB-6636	66"	74	854
PB-7236	72"	80	916
PB-7836	78"	87	940
PB-8436	84"	81	969
PB-9036	90"	86	1075
PB-9636	96"	110	1153

30" "P" shaped peninsula

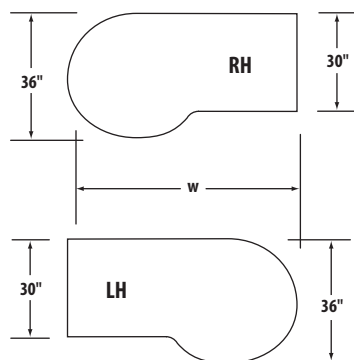

left hand		right hand		list price
model #	model #	w	lbs	"B" (banded)
PPB-6630L	PPB-6630R	66"	74	\$940
PPB-7230L	PPB-7230R	72"	80	1036
PPB-7830L	PPB-7830R	78"	86	1316
PPB-8430L	PPB-8430R	84"	92	1354
PPB-9030L	PPB-9030R	90"	97	1385

36" "P" shaped peninsula

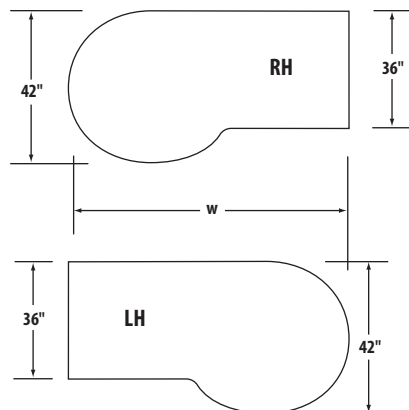

left hand		right hand		list price
model #	model #	w	lbs	"B" (banded)
PPB-6636L	PPB-6636R	66"	86	\$969
PPB-7236L	PPB-7236R	72"	92	1052
PPB-7836L	PPB-7836R	78"	99	1332
PPB-8436L	PPB-8436R	84"	107	1371
PPB-9036L	PPB-9036R	90"	115	1400



please specify:

- model number
- coating color

see also:

- *Enamel Selection Guide*

end panels

Unitized steel end panels are reversible for left- or right-hand attachment to worksurface with included mounting screws.

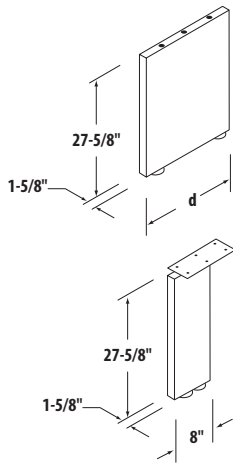

end panel

model #	d	worksurface depth	lbs	list price
E20	18"	20"	18	\$300
E24	23"	24"	28	348
E30	28"	30"	33	423
E36	34"	36"	39	517

double end panel –

adjoins two worksurfaces or supports middle of longer worksurface. Primarily used on longer returns and returns with modesty panels.

model #	lbs	list price
E8	16	\$179

tube legs

Cylindrical steel tube legs attach to worksurface with included mounting screws. Tube legs come with adjustable floor glide(s)

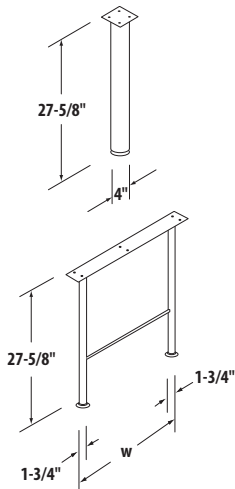

single tube leg –

attaches to unsupported end of any 20", 24" or 30" deep peninsula worksurface. May also be used to adjoin two tops or as a center support for corner tops.

model #	lbs	list price
STL	7	\$161

double tube leg –

attaches to unsupported end of 20", 24" or 30" deep worksurface.

model #	w	lbs	list price
DTL20	20"	7	\$247
DTL24	24"	8	268
DTL30	30"	9	278

specialty support components

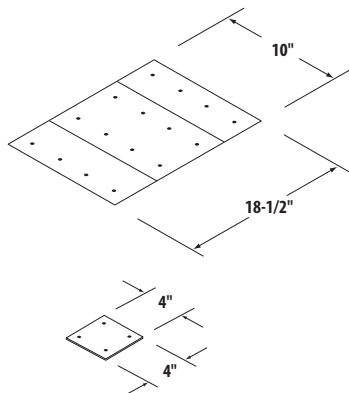

wood core clamp –

attaches two adjacent worksurfaces – primarily used for returns and short bridge tops. Medium grey.

model #	lbs	list price
WC20	3	\$57

flat bracket –

attaches two adjacent worksurfaces – primarily used to supplement and strengthen seams. Medium grey.

model #	lbs	list price
FB-1	0.5	\$8



c-legs

Unitized steel c-legs attach to worksurface with included mounting screws. C-legs come with adjustable floor glides.

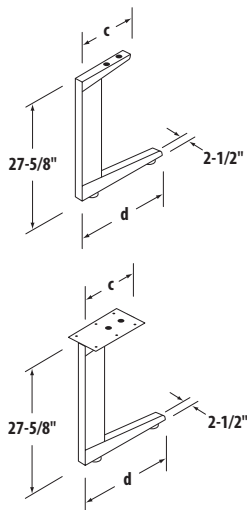

single c-leg

model #	d	c	lbs	list price
C20	16-1/2"	16-1/2"	12	\$260
C24	22-1/2"	16-1/2"	13	302
C30	28-1/2"	22-1/2"	15	354

double c-leg –

adjoins two worksurfaces or supports middle of longer worksurface

model #	d	c	lbs	list price
C20D	16-1/2"	16-1/2"	13	\$286
C24D	22-1/2"	16-1/2"	15	324
C30D	28-1/2"	22-1/2"	17	371

e-lift legs

e-lift legs attach to worksurface with included mounting screws. e-lift legs come with adjustable floor glides, and adjustable height range from 24H - 50H. Coatings are limited. *Includes simple two button control.*

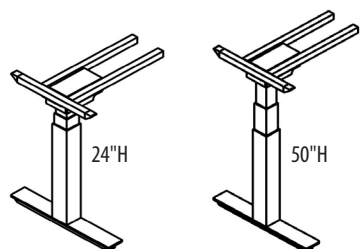

e-lift leg - left hand

model #	d	h	list price
2L2M	20", 24" & 30"	24" - 50"	\$974
3L3M	20", 24" & 30"	24" - 50"	1461

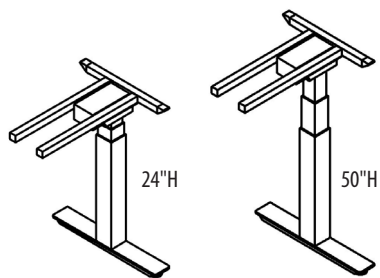

e-lift leg - right hand

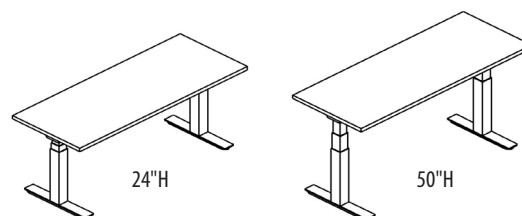

2L2M - 2-leg / 2 motor

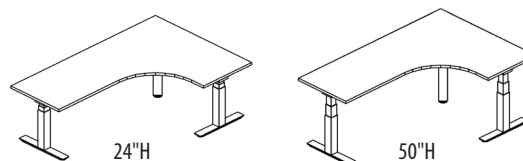

3L3M - 3-leg / 3 motor

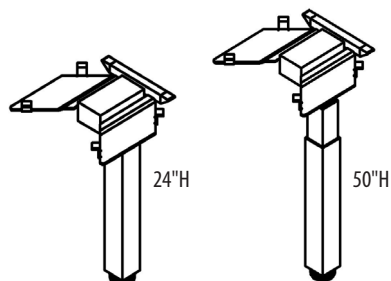

e-lift leg - for l-shape desks

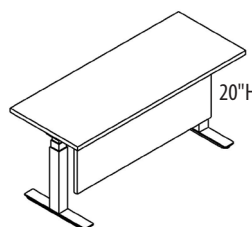

modesty shield option –

For optional 20"H modesty shield. List price is \$220. Dimension will be determined by factory. Model # MS-XX. Example: MS-48



freestanding pedestals

please specify:

- model number
- coating color
- laminate ("LAM" option only)

see also:

- pedestal drawer options (*next page*)

freestanding pedestals

Freestanding pedestals come standard with cradle type, full suspension file drawers. Pedestals are enclosed on all six sides and welded and brazed on all eight corners. Standard with four mounting holes, pedestals may be ordered with optional finished tops (no mounting holes). Freestanding pedestals may be used alone, placed beneath 29" or higher worksurfaces or used to support worksurfaces. All pedestals come standard with lock.

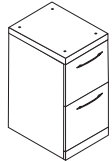

20" deep –
file/file

model #	w	d	h	lbs	list price
20F	15"	18-1/2"	27-5/8"	54	\$780

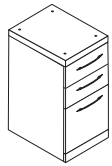

20" deep –
box/box/file

model #	w	d	h	lbs	list price
20B	15"	18-1/2"	27-5/8"	57	\$780

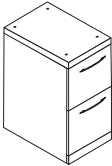

24" deep –
file/file

model #	w	d	h	lbs	list price
24F	15"	23-1/2"	27-5/8"	66	\$841

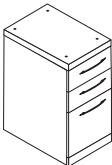

24" deep –
box/box/file

model #	w	d	h	lbs	list price
24B	15"	23-1/2"	27-5/8"	69	\$841

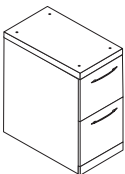

30" deep –
file/file

model #	w	d	h	lbs	list price
30F	15"	28-3/4"	27-5/8"	82	\$972

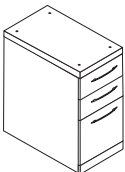

30" deep –
box/box/file

model #	w	d	h	lbs	list price
30B	15"	28-3/4"	27-5/8"	86	\$972

NOTE: for finished top (no mounting holes) add "FT" to model # and add \$29 to list price. (example: 24F-FT = \$870)

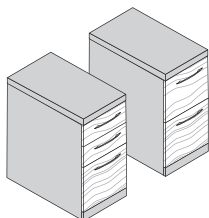

Optional Laminate Drawer Front –
Add "LAM" to model # and add \$361 to list price.
(example: 24F-LAM = \$1202)



please specify:

- model number
- coating color
- fabric (ched)

see also:

• Chair Fabric Selection Guide

mobile pedestals

Mobile pedestals come standard with cradle type, full suspension file drawers. Pedestals are completely finished, enclosed on all six sides and welded and brazed on all eight corners. Mobile pedestals may be used alone or placed beneath 29" or higher worksurfaces. All pedestals come standard with lock.

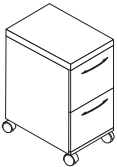

24" deep –
file/file

model #	w	d	h	lbs	list price
24FM	15"	23-1/2"	27-5/8"	66	\$735



24" deep –
box/box/file

model #	w	d	h	lbs	list price
24BM	15"	23-1/2"	27-5/8"	69	\$735

mobile pedestal with seat cushion

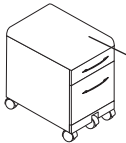

24" deep –
convenience/file
specify fabric
(see Chair Fabric Selection Guide)

model #	w	d	h	lbs	list price
CHED	15"	23-1/2"	21"	55	\$750

pedestal drawer options

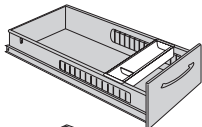

pencil tray --
supplied in black.

model #	lbs	list price
PT-1	0.2	\$15

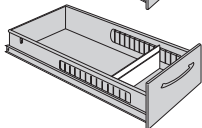

drawer divider --
supplied in medium grey.

model #	lbs	list price
DD-1	0.2	\$8

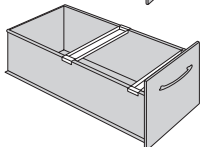

dual hanging crossbars --
converts letter to side-to-side legal; supplied in medium grey.

model #	lbs	list price
F-HFB-C	1	\$41

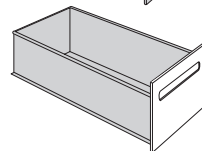

recessed pulls --
no charge. Specify on order:
"recessed pulls".
(Not available on "CHED")

model #	lbs	list price
LC-1	4oz	\$41

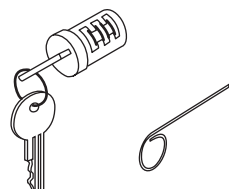

additional lock core, key & pick --
field installation only. Includes core, pick and two keys (keyed random or specify #)

model #	lbs	list price
KO-F	2oz	\$24

additional key --
specify lock number when ordering.



under top bookcases

please specify:

- model number
- coating color

see also:

- complete line of bookcases (page 214)

under top bookcases

Steel bookcases are designed to support worksurfaces or simply stand alone. **Dimensions exactly match Suzy freestanding pedestals** (see page 98). Bookcases come standard with adjustable glides and 1 ea. height adjustable shelf (additional shelves available - see below).

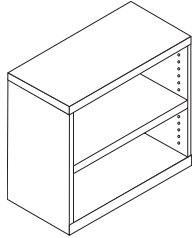

model #	w	d	h	lbs	list price
NBC24	23-1/2"	13-5/8"	27-5/8"	28	\$519
NBC30	28-5/8"	13-5/8"	27-5/8"	35	568
NBC36	35-5/8"	13-5/8"	27-5/8"	42	605

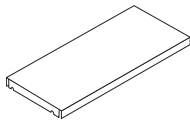

additional shelf –
mounting brackets included.

model #	w	lbs	list price
NBC24-SHELF	21-1/2"	4	\$51
NBC30-SHELF	26-5/8"	4	57
NBC36-SHELF	32-5/8"	4	63

typical configurations:

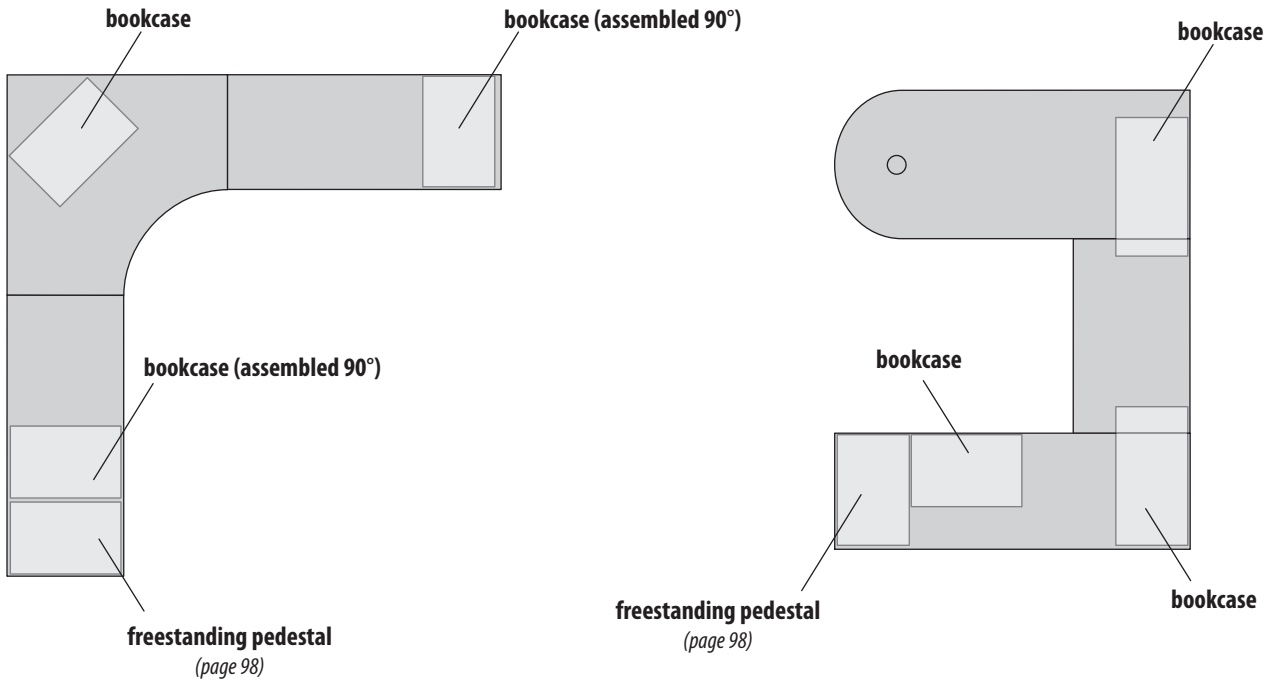

please specify:

- model number
- coating color

2 drawer under top lateral file

2 drawer lateral files feature an interlock system which allows only one drawer to be opened at a time. Comes standard with front-to-back letter filing – option DHF (see below for other options). May be used alone, placed beneath 29" or higher worksurfaces or used to support worksurfaces.

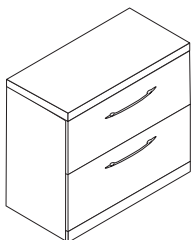

no lock

model #	w	d	h	lbs	list price
S30-200	30"	18"	27-3/4"	115	\$898
S36-200	36"	18"	27-3/4"	128	950
S42-200	42"	18"	27-3/4"	141	1003

with lock

model #	w	d	h	lbs	list price
S30-201	30"	18"	27-3/4"	118	\$935
S36-201	36"	18"	27-3/4"	131	990
S42-201	42"	18"	27-3/4"	144	1045

drawers

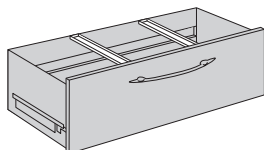

front-to-back letter filing –
standard. For more drawer options, see lateral file section on pages 201.

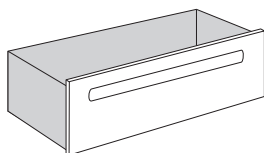

P Series recessed pulls –
no charge. Specify on order: "recessed pulls"

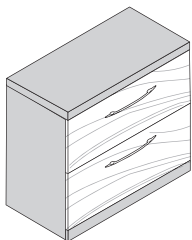

optional laminate drawer fronts –
Add "LAM" to model # and add \$377 to list price.
(example: S30-201 LAM = \$1312)



hutches

please specify:

- model number
- coating color
- fabric (hutch tackboards)

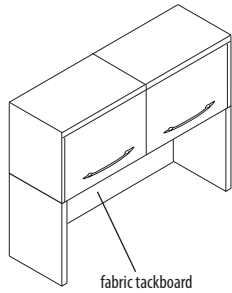

storage hutch –
mount to corresponding desks, credenzas or returns. Attachment hardware included. Fully enclosed, tackboard included. Underside of hutch accommodates optional task lights.

no lock

<i>model #</i>	<i>w</i>	<i>d</i>	<i>h</i>	<i>lbs</i>	<i>list price</i>
H36	36"	13-1/2"	36"	52	\$1259
H42	42"	13-1/2"	36"	62	1381
H48	48"	13-1/2"	36"	72	1495
H54	54"	13-1/2"	36"	82	1621
H60	60"	13-1/2"	36"	92	1959
H66	66"	13-1/2"	36"	99	2099
H72	72"	13-1/2"	36"	108	2207
H78	78"	13-1/2"	36"	117	2408
H84	84"	13-1/2"	36"	126	2556

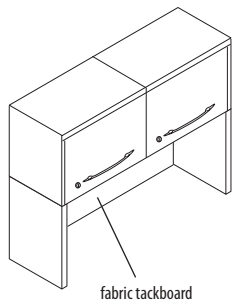

storage hutch with lock –
mount to corresponding desks, credenzas or returns. Attachment hardware included. Fully enclosed, tackboard included. Underside of hutch accommodates optional task lights.

with lock

<i>model #</i>	<i>w</i>	<i>d</i>	<i>h</i>	<i>lbs</i>	<i>list price</i>
H36L	36"	13-1/2"	36"	52	\$1328
H42L	42"	13-1/2"	36"	62	1450
H48L	48"	13-1/2"	36"	72	1537
H54L	54"	13-1/2"	36"	82	1691
H60L	60"	13-1/2"	36"	92	2099
H66L	66"	13-1/2"	36"	99	2239
H72L	72"	13-1/2"	36"	108	2346
H78L	78"	13-1/2"	36"	117	2548
H84L	84"	13-1/2"	36"	126	2640

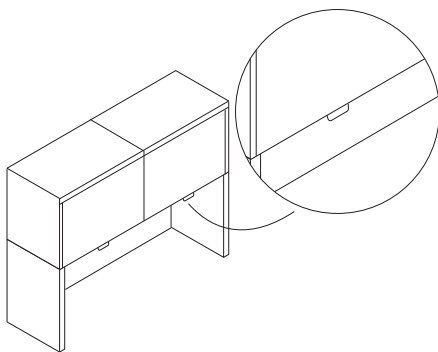

tab pull option –
no charge. Specify on hutch order: "tab pulls".

storage unit task light

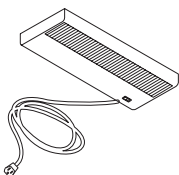

task light –
fits beneath overhead units and open shelves. LED task light features dimming 100% - 15%, 12 hour auto shut-off, 80+ color rendering index @ 3500k, and a 52,000 hour life span. Available in silver only.

<i>model #</i>	<i>light width</i>	<i>lbs</i>	<i>list price</i>
OTL-17	18-5/8"	4	\$269
OTL-31	32-5/8"	5	282
OTL-44	45-5/8"	6	303



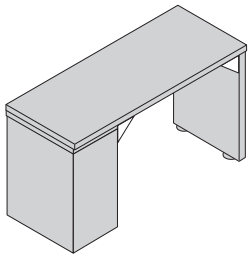

no modesty (brackets only) –
provides complete access to walls. Corner brackets add strength. Not recommended for openings wider than 50".

model #	lbs	list price
NM	1	\$40

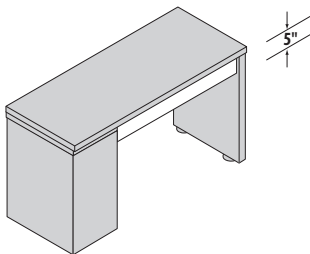

short modesty –
panel provides strength and almost complete access to walls.

model #	lbs	list price
SM	5	\$81

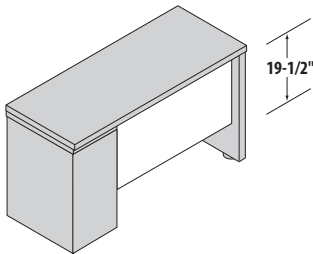

3/4 modesty –
panel provides strength and privacy, with access to floor.

model #	lbs	list price
3M	14	\$140

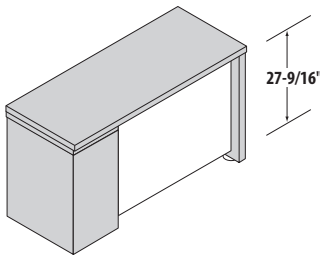

full height modesty –
panel provides strength and privacy.

model #	lbs	list price
FM	18	\$179

please specify:
• model number

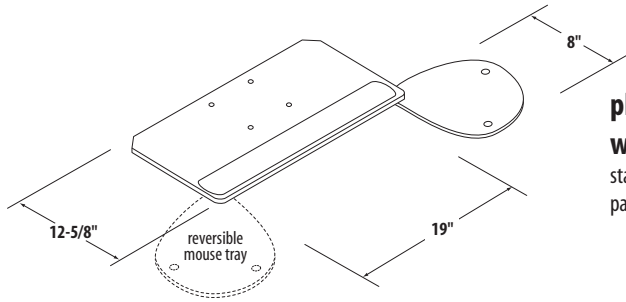

phenolic keyboard platform with reversible mouse tray – standard with Stasoft™ synthetic leather palm support.

Model #	w	d	lbs	list price
MP-19	19"	9-1/2"	3	\$272
MPLA-19	19"	12"	3	284

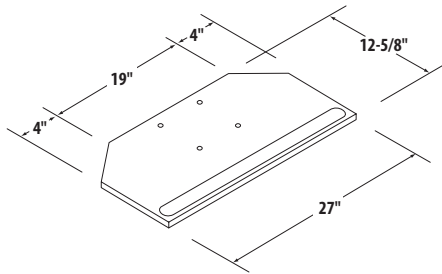

phenolic mouse-width platform – standard with Stasoft™ synthetic leather palm support. Mouse width, black only.

Model #	w	d	lbs	list price
SP-27	27"	9-1/2"	4	\$196
SPLA-27	27"	12"	4	208

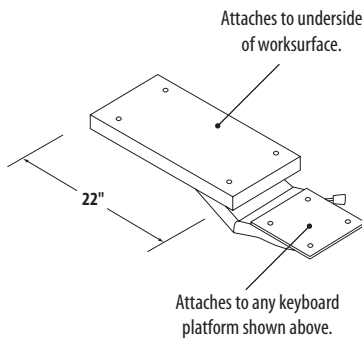

passive adjust keyboard mechanism – adjustments include: platform tilt ($\pm 15^\circ$), up/down, in/out, and 360° rotation. Up/down adjustment is spring assisted and is controlled by simply lifting up on the front of the attached platform. Features a slim-line profile beneath the platform. Available in black only.

Standard

Model #	w	d	lbs	list price
PA-22	5"	22"	11	\$269
PA-17	5"	17"	10	275

Sit/Stand

Model #	w	d	h	lbs	list price
PA22-SS	5"	22"	24" - 38"	11	\$347

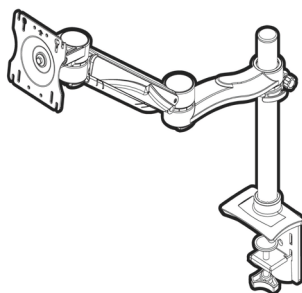

sit/stand monitor arm – adjustments include: swivels, tilts, moves in & out, up & down. Moving monitor from seated to standing height is quick and easy. Grommet or clamp mounts. Available in black only. VESA compatible. 20 pound capacity.

Model #	w	d	h	lbs	list price
SS-7818H	5"	7"	7" - 25"	6	\$508



please specify:

- model number
- coating color (corner sleeve)

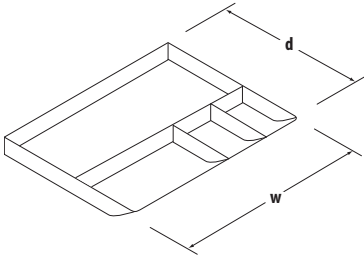

pencil drawer – self contained pencil drawer is designed to attach to the underside of any Suzy work-surface. Mounting hardware included. Available in black only.

Model #	w	d	lbs	list price
PPT-1	20-1/2"	22"	3	\$160

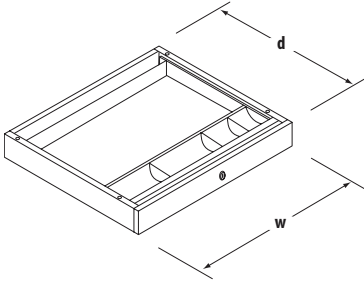

security drawer – self contained, secure and strong. Accommodates laptop computers up to 11-1/4" d x 1-5/8"h x 19-1/2"w. Pencil tray included. Entire unit doubles as a pencil drawer. Lock comes standard. Specify enamel color.

with lock

Model #	w	d	h	lbs	list price
SD-21L	21-3/8"	21"	2-7/8"	12	\$287

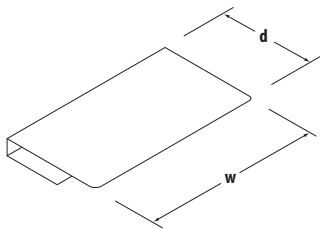

corner sleeve – transforms a 90° corner into a corner computer workstation. Attaches to Suzy work-surfaces with included hardware. Specify coating color.

Model #	w	d	lbs	list price
CS-17	17"	10-5/8"	5	\$116
CS-21	21"	10-5/8"	6	\$116

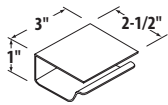

horizontal cable trough – horizontal cable management trough. For field installation only. Attaches to underside of worksurface with screws. Sold in packages of four which include screws.

Model #	w	lbs	list price
HCT-4	3"	1.4	\$39 (per package of 4)



scallops & grommets

please specify:

- model number
- location (see below)

scallops – scallops are designed for simple cord management along the edge of a worksurface.

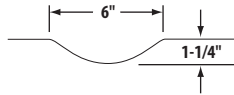

S-1

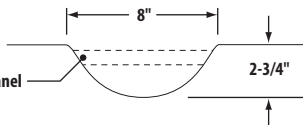

SS-1

hutch or modesty panel

For use in combination with modesty panel and/or hutch.

model #	description	list price
S-1	scallop	\$33
SS-1	super scallop	46
G-1	grommet (black only)	24

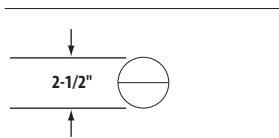

G-1

2-1/2" dia. grommet with integrated cover. Black only.

specifying – sketch suzy model and dimension accordingly:

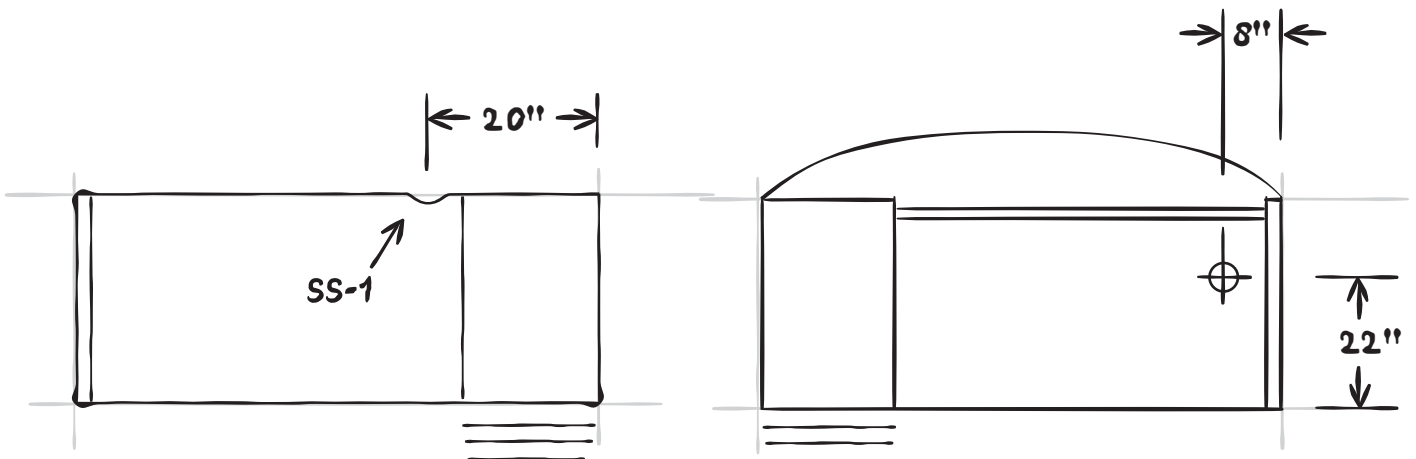

example: B-6024 E24 24B 3M with SS-1

example: BB-8436 30B E30 FM with G-1





please specify:

- model number
- coating color

personal locker

Suzu personal lockers are heavy duty steel constructed and enamel finished. Lockers have standard high-sided drawers complete with steel wheel & ball bearing suspension. Base unit drawers and locker door come standard with locks.

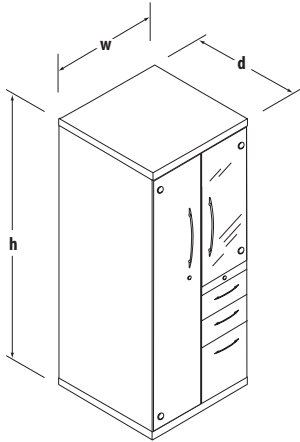

base unit features –

- locker with garment rod
- 2-box and 1-file drawer
- drawers and locker door with lock
- cabinet with frosted plexi door and binder-height inner shelf

model #	w	d	h	lbs	list price
PL-24	23-13/16"	23-1/2"	50-3/16"	152	\$3078

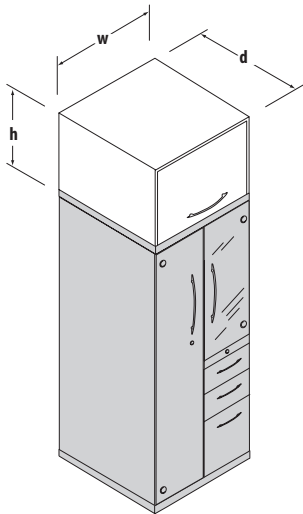

storage bin features –

- full depth storage with receding door
- stores laptop cases, large tote bags, briefcases, etc.
- arrives fully assembled to personal locker base unit

with lock

model #	w	d	h	lbs	list price
PLSB-24	23-13/16"	23-1/2"	13-13/16"	36	\$780
PLSB-24L	23-13/16"	23-1/2"	13-13/16"	36	870

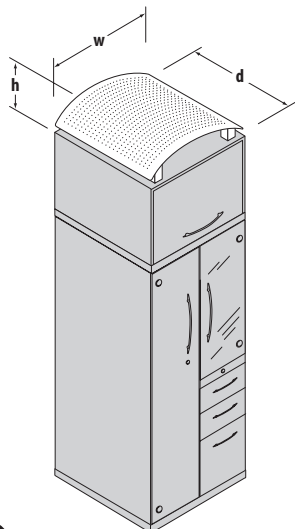

storage hood features –

- perforated steel arched storage hood
- stores blueprints, umbrellas, etc.
- attaches to storage bin or base unit
- arrives attached and fully assembled

model #	w	d	h	lbs	list price
PLH-24	23-13/16"	23-1/2"	7-3/8"	8	\$495



please specify:

- model number
- coating (frame & tool tiles)
- fabric (tackboard)

see also:

- Panel Fabric Selection Guide

wall mounted frames and fasteners

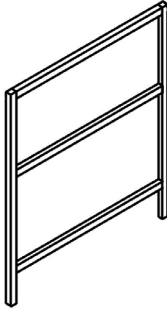

wall mounted frame –

frame mounts to wall using 1/4" fasteners.

model #	w	h	description	lbs	list price
WMF-24	24"	34"	overhead unit + 21" tile		\$203
WMF-30	30"	34"	overhead unit + 21" tile		203
WMF-36	36"	34"	overhead unit + 21" tile		203
WMF-42	42"	34"	overhead unit + 21" tile		203
WMF-48	48"	34"	overhead unit + 21" tile		203
WMF-54	54"	34"	overhead unit + 21" tile		203

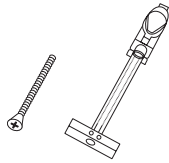

wall mount strip fasteners (toggles)–

mount wall hanger strips to standard dry-wall. Order one per foot of per wall hanger strip.

model #	lbs	list price
WFK-1	.05	\$8

wall mounted units

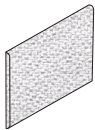

tackboard – sound dampening tackboard specially designed to mount to wall mounted frame (shown above).

model #	w	h	description	lbs	list price
TBW-2124	24"	21"	24" wide wall mount unit	7	\$180
TBW-2130	30"	21"	30" wide wall mount unit	9	203
TBW-2136	36"	21"	36" wide wall mount unit	11	261
TBW-2142	42"	21"	42" wide wall mount unit	13	304
TBW-2148	48"	21"	48" wide wall mount unit	15	334
TBW-2154	54"	21"	54" wide wall mount unit	17	372



please specify:

- model number
- coating color (*storage bin*)
- laminate (*laminated storage bin*)
- fabric (*tackboards*)

see also:

- task lights (*below*)
- wall mounted frame (*previous page*)
- *Laminate Selection Guide*

storage units - wall mounted frames

Suzu storage units mount to corresponding wall mounted frames (*see previous page*). Standard mounting height is 21" above the worksurface. Optional task lights can be added (*see below*).

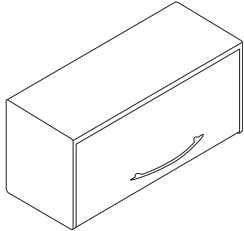

storage bin –

for optional lock, add "L" to model number and add \$71 to list price.
Example: SB-24L = \$509

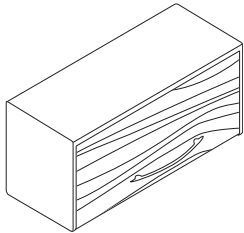

laminated door storage bin –

for optional lock, add "L" to model number and add \$71 to list price.
Example: LSB-24L = \$625

model #	w	d	h	lbs	list price
SB-24	23-3/4"	13-1/2"	13-3/4"	25	\$438
SB-30	29-3/4"	13-1/2"	13-3/4"	30	487
SB-36	35-3/4"	13-1/2"	13-3/4"	36	551
SB-42	41-3/4"	13-1/2"	13-3/4"	41	616
SB-48	47-3/4"	13-1/2"	13-3/4"	47	665
SB-54	53-3/4"	13-1/2"	13-3/4"	53	731

model #	w	d	h	lbs	list price
LSB-24	23-3/4"	13-1/2"	13-3/4"	25	\$586
LSB-30	29-3/4"	13-1/2"	13-3/4"	30	639
LSB-36	35-3/4"	13-1/2"	13-3/4"	36	736
LSB-42	41-3/4"	13-1/2"	13-3/4"	41	806
LSB-48	47-3/4"	13-1/2"	13-3/4"	47	878
LSB-54	53-3/4"	13-1/2"	13-3/4"	53	978

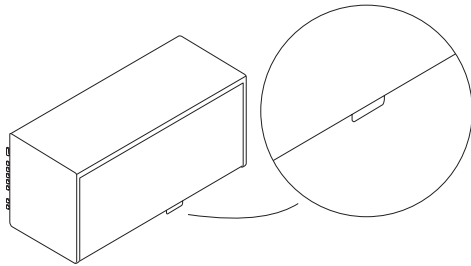

tab pull option –

no charge.
Specify on order: "recessed pulls"

storage unit task light

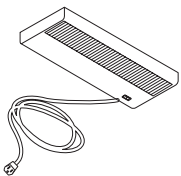



task light –

fits beneath overhead units and open shelves. LED task light features dimming 100% - 15%, 12 hour auto shut-off, 80+ color rendering index @ 3500k, and a 52,000 hour life span. Available in silver only.

model #	light width	lbs	list price
OTL-17	18-5/8"	4	\$264
OTL-31	32-5/8"	5	282
OTL-44	45-5/8"	6	298



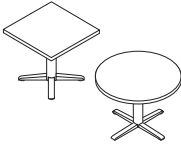
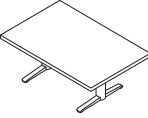

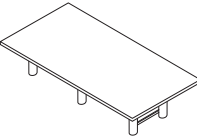
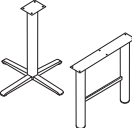
	product overview	page 114
	square and round tables	page 116
	rectangular tables	page 117
	racetrack tables	page 118
	conference tables	page 119
	legs	page 120

product overview

McDowell-Craig Tables may be used in a variety of office and institutional environments — such as conference areas, office workstations, classrooms, computer training and lunch rooms. Besides their versatility, these tables are built to last.

tops

Table tops are constructed of 1-3/16" industrial grade particle board covered with high pressure, plastic laminates, and self edged or vinyl edged.

top laminates

Standard Laminates – A variety of laminate patterns, solids, and wood grains are available. See McDowell-Craig Plastic Laminates Selection Guide for standard selections.

Special Laminates – Worksurfaces may be ordered with factory approved special laminates – add 8% to price of unit. + \$722 per pattern per order.

Note: written factory approval must accompany your order.

base construction

Tables are supported by rigid, steel tubular bases – engineered and manufactured to last. Each base leg includes an adjustable glide to compensate for uneven floors.

base finishes

Standard Coating – Table bases are available in a variety of color coordinated, high solid coatings.

Special Coating – Components may be ordered in factory approved special high solid baked coating – add 8% to price of unit + \$1016 set-up & mixing charge per color per order. *Note: written factory approval must accompany your order.*

conference tables
T-legs

please specify:

- model number
- coating
- laminate

standard features include –

All tables come standard with a 1-5/16" thick top. All bases come standard with adjustable floor glides.

square table

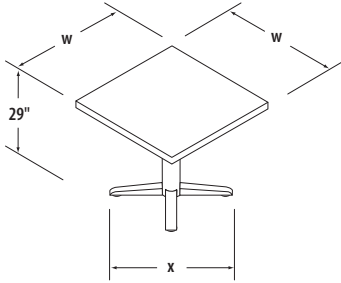

					list price
model #	w	h	x	lbs	"BT" (banded)
CT-3030BT	30"	29"	29	52	\$853
CT-3636BT	36"	29"	38	68	999
CT-4242BT	42"	29"	46	84	1241

round table

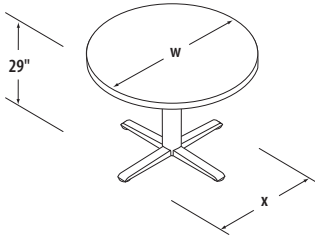

					list price
model #	w	h	x	lbs	"BT" (banded)
CT-30BT	30"	29"	25	44	825
CT-36BT	36"	29"	29	57	969
CT-42BT	42"	29"	38	71	1060
CT-48BT	48"	29"	46	87	1285

30" deep conference table – T-legs

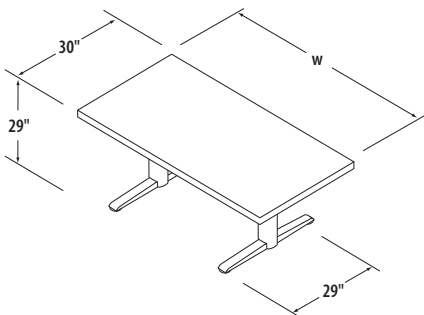

				list price
model #	w	h	lbs	"BT" (banded)
CT-4230BT	42"	25"	72	1073
CT-4830BT	48"	25"	78	1167
CT-6030BT	60"	25"	90	1235
CT-7230BT	72"	25"	103	1381
CT-8430BT	84"	25"	116	1455



36" deep conference table – T-legs

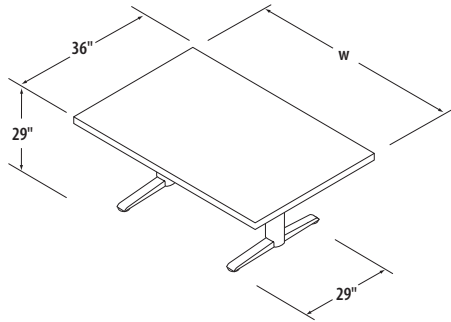

				list price
model #	w	h	lbs	"BT" (banded)
CT-4236BT	42"	29"	82	\$1181
CT-4836BT	48"	29"	89	1228
CT-6036BT	60"	29"	103	1332
CT-7236BT	72"	29"	117	1437
CT-8436BT	84"	29"	131	1552

42" deep conference table – T-legs

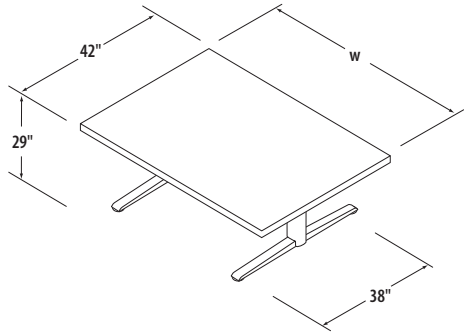

				list price
model #	w	h	lbs	"BT" (banded)
CT-6042BT	60"	29"	115	\$1620
CT-7242BT	72"	29"	134	1893
CT-8442BT	84"	29"	152	1960

tables



conference tables
T-legs (cont'd)

please specify:

- model number
- coating
- laminate

standard features include –

All tables come standard with a 1-3/16" thick top. All bases come standard with adjustable floor glides.

30" deep racetrack tables

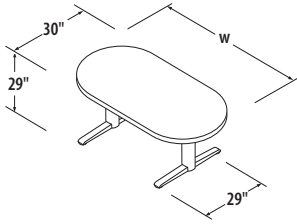

				list price
model #	w	h	lbs	"BT" (banded)
RCT-4230BT	42"	29"	74	\$1105
RCT-4830BT	48"	29"	81	1202
RCT-6030BT	60"	29"	95	1272
RCT-7230BT	72"	29"	110	1422
RCT-8430BT	84"	29"	123	1499

36" deep racetrack tables

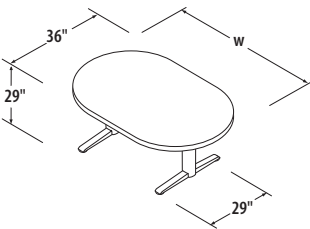

				list price
model #	w	h	lbs	"BT" (banded)
RCT-4836BT	48"	29"	79	1228
RCT-6036BT	60"	29"	93	1332
RCT-7236BT	72"	29"	107	1437
RCT-8436BT	84"	29"	121	1552

42" deep racetrack tables

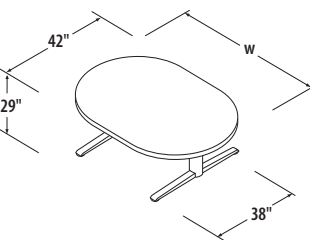

				list price
model #	w	h	lbs	"BT" (banded)
RCT-6042BT	60"	29"	103	\$1620
RCT-7242BT	72"	29"	122	1893
RCT-8442BT	84"	29"	140	1960



conference table

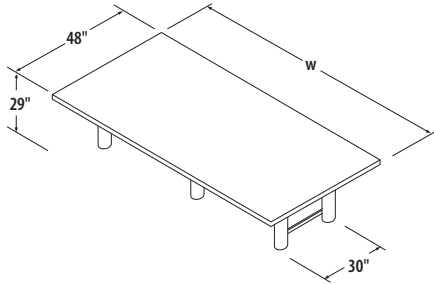

model #	w	h	lbs	list price
				"BT" (banded)
CT-9648BT	96"	29"	220	\$3179
CT-10848BT	108"	29"	240	3407
CT-12048BT	120"	29"	260	3634
CT-14448BT (2 pcs.)	144"	29"	300	4239
CT-16848BT (2 pcs.)	168"	29"	340	4844

racetrack conference table

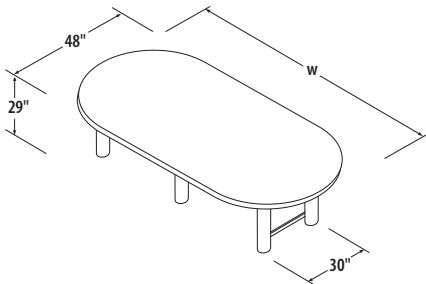

model #	w	h	lbs	list price
				"BT" (banded)
RCT-9648BT	96"	29"	200	\$3331
RCT-10848BT	108"	29"	220	3559
RCT-12048BT	120"	29"	240	3784
RCT-14448BT (2 pcs.)	144"	29"	280	4391
RCT-16848BT (2 pcs.)	168"	29"	320	4996

boat-shaped conference table

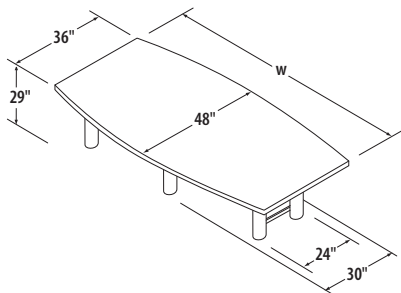

model #	w	h	lbs	list price
				"BT" (banded)
BCT-9648BT	96"	29"	215	\$3481
BCT-10848BT	108"	29"	235	3709
BCT-12048BT (2 pcs.)	120"	29"	255	3937
BCT-14448BT (2 pcs.)	144"	29"	295	4542
BCT-16848BT (2 pcs.)	168"	29"	335	4632



please specify:

- model number
- coating

standard features include –

All bases come standard with commercial-grade domestic tubing, brazed joints, and heavy-duty adjustable floor glides.

T leg bases

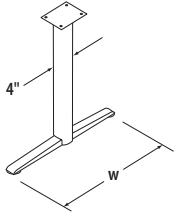

single T leg base

<i>model #</i>	<i>w</i>	<i>h</i>	<i>lbs</i>	<i>list price</i>
T2-25	25"	27 - 5/8"	14	\$339
T2-29	29"	27 - 5/8"	15	371
T2-38	38"	27 - 5/8"	17	402

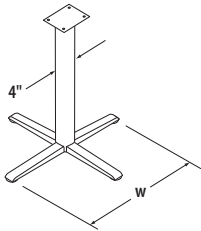

double t leg base

<i>model #</i>	<i>w</i>	<i>h</i>	<i>lbs</i>	<i>list price</i>
T4-29	29"	27 - 5/8"	23	\$557
T4-38	38"	27 - 5/8"	27	586
T4-46	46"	27 - 5/8"	31	710

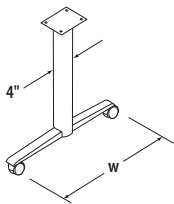

single T leg base with locking casters

<i>model #</i>	<i>w</i>	<i>h</i>	<i>lbs</i>	<i>list price</i>
T2-29C	29"	27 - 5/8"	23	\$525
T2-38C	38"	27 - 5/8"	27	557

H legs

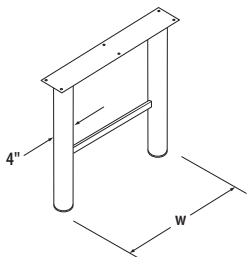

H leg base

<i>model #</i>	<i>w</i>	<i>h</i>	<i>lbs</i>	<i>list price</i>
HT-24	24"	27 5/8"	20	\$563
HT-30	30"	27 5/8"	21	595







Consumer Price List #38 – Effective January 1, 2022



task chairs



synchro-tilt self-adjusting task chair..... page 126

guest chairs



stackable guest seating..... page 127



chair upholstery

Standard Fabrics — A variety of quality fabrics are available. See *McDowell-Craig Fabric Selection Guide*. All fabrics meet the flammability requirements of the *California Technical Information Bulletin #117*.

Special Fabrics — Add \$104 per fabric per order and contact factory for individual chair pricing. Special fabric supplied by customer, add per chair: \$29.

Vinyl — Add \$101 per vinyl per order and add per chair: \$123. Vinyl supplied by customer, add per chair: \$81.

leather pricing

McDowell-Craig uses only the finest upholstery grade leather as our standard.

TC 100 and TC 400 Series — Standard hard-shell outer-back: \$254

TC 100 Series — Four leg guest chairs: \$275

Customer's own Leather (C.O.L) — All chairs: \$138

chair customer's own material (C.O.M.) chart

number of chairs	fabric and vinyl		leather	
	standard	w/ upholstered back (option H)	standard	w/ upholstered back (option H)
1-5	1 yard per chair	1.5 yards per chair	.50 hide per chair	.75 hide per chair
6 +	.85 yard per chair	1.2 yards per chair	.50 hide per chair	.75 hide per chair

arm rests

Trek 100 and 400 Series Chairs — standard arm pads are self-skinned urethane with integrated memory foam and a matte black textured finish.

Trek Stackable Guest Chairs — arm rests are integral skinned poly-urethane with a matte black textured finish.

seats

Trek Stackable Guest Chairs — come standard with curved seat and back, fully upholstered over 1-1/2" thick, high-resilient foam.

Trek 100 and 400 Series — come standard with multiple density contoured seat cushions and integrated memory foam.

back rests

Trek 100 and 400 Series — standard back rest is contoured soft density foam with additional medium density lumbar foam inserts for optimal lower back support. Hard shell outer-back.

Trek Stackable Guest Chairs — standard back rest is fully upholstered over 1" thick, high-resilient foam front. Back upholstery is over 1/2" thick, standard foam backing. This back rest is sculptured to fully support the back, placing extra support on the lumbar.

steel frames

Trek Stackable Guest Chairs — frame is constructed of 16 gauge, 1" domestic steel tubing with high-solid, baked enamel finish.

casters

Dual wheel carpet casters — come standard.

Soft dual wheel hard floor casters — \$29 per chair

warranty information

Pneumatic cylinder / chair control — 12 years

High wear parts (Fabric, Cushions, Casters, Arms and Glides) — 5 years

All other parts — Lifetime



**task chair
synchro-tilt**

please specify:

- model number
- fabric

see also:

- special fabrics, vinyl, casters, and leather upcharges (page 185)

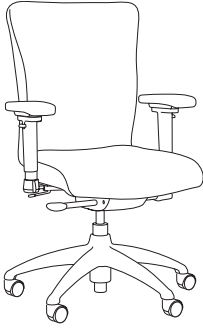

TC-460 self-adjusting task chair with arms –

2 : 1 synchro-knee tilt, tilt tension control, lumbar support adjustment, pneumatic seat height adjustment, full-range arm control including: depth, height and width, seat depth adjustment, and full-range tilt lock. Integrated operational guide. Hard shell outer-back.

27-1/2"w x 24"d x 44"h

model #	lbs	list price
TC-460	50	\$962



TC-450 self-adjusting task chair

24"w x 24"d x 44"h

model #	lbs	list price
TC-450	41	\$865



optional mesh-back –

In lieu of standard hard shell, fabric back.

model #	lbs	list price
TC-460M	50	\$855
TC-450M	41	\$845

synchro-tilt self-adjustment feature details

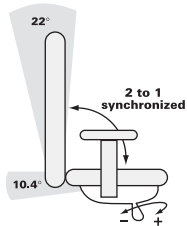

2 : 1 synchronized tilt –

This standard feature facilitates the seat and back movement to synchronize at a 2 to 1 ratio (as shown at left). Spontaneous body support provided by the synchronization of seat and back promotes circulation and reduces fatigue.



- model number
- fabric
- coating (*matte black will be specified if no coating choice made on order*)

- special fabrics, vinyl, casters and leather upcharges (*page 185*)

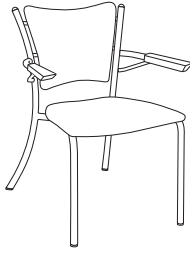

TC-115 stackable guest chair with arms –

Five high stacking. Contoured lumbar support. Very light, strong and comfortable.

25"w x 23-1/2"d x 33-1/2" h

model #	lbs	list price
TC-115	18	\$597

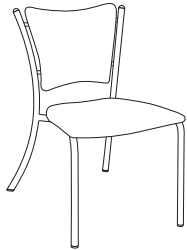

TC-110 stackable guest chair

20"w x 23-1/2"d x 33-1/2" h

model #	lbs	list price
TC-110	16	\$380

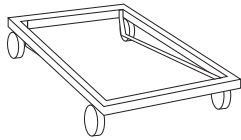

TC-CART stackable guest chair cart–

For use with TC-115 and TC-110 stackable guest chairs. 5" dia. heavy duty wheels. Holds up to 12 chairs.

22"w x 33"d x 7-1/2" h

model #	lbs	list price
TC-CART	35	\$646



fling and storage

Consumer Price List #38 – Effective January 1, 2022



overview page 131



lateral files S-series page 132

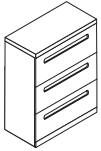

lateral files P-series page 134

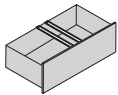

lateral file accessories & tops page 136

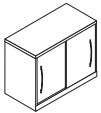

over-file storage page 138



vertical files norwalk series page 142



vertical files P-series page 144

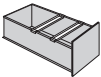

vertical files accessories & tops page 144

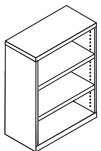

bookcases page 146

filing and storage

product overview

Vertical Files — With a track record of dependability that spans well over half a century, these rugged steel files feature 6 vertical uprights, 14 GA. tie bar gussets that maintain strong, straight drawer openings, full suspension cradles, 8 steel wheel roller bearings and 2 steel idler bearings per drawer, satin brushed aluminum hardware, and standard thumb latches.

Lateral Files — S Series and P Series Lateral files offer comprehensive solutions for a variety of office filing situations while maintaining a beautiful and consistent appearance. Whether beneath a work surface, within a project center, or in a group of central files, the clean lines and durable construction create a balance of form and function that remains consistent throughout the entire office. While a handsome addition to any office, these well-designed files retain their value by remaining completely scalable to a growing office — start with personal filing, add volume with a bank of files, expand their function with overhead storage, create workstation enclosures, add counters complete with laminate tops — as the filing needs of your office grow, the functionality of these lateral files grows right with it.

lateral file drawers and roll-out shelves

All McDowell-Craig lateral file drawers and roll-out shelves operate on steel roller ball bearings that allow for full extension and maximum accessibility to contents. 4 and 5 drawer files have torque plates to ensure squareness and straight drawer openings. A variety of drawers and / or shelves are available; additionally, different drawer and / or shelf arrangements may be made in the field at any time — including the addition or removal of receding doors. All McDowell-Craig lateral files are engineered to be moved fully loaded.

finishes

Standard Enamel — All McDowell-Craig files are available in a variety of color coordinated, high solid baked enamel finishes. *See McDowell-Craig Enamel Selection Guide.*

Special Enamel — All McDowell-Craig files may be ordered in factory approved special high solid baked enamel finishes — add 8% to price of unit + \$1015 set-up and mixing charge per color per order. **Note:** *written factory approval must accompany your purchase order.*

laminated tops

Standard Tops — Tops are banded or self-edged and available in a variety of wood grains and patterns. *See McDowell-Craig Plastic Laminate Selection Guide.*

Special Laminates — Tops may be ordered in factory approved special laminates — add 8% to price of unit + \$720 per laminate pattern per order. **Note:** *written factory approval must accompany your purchase order.*

locks

McDowell-Craig files, pedestals and lockers are available with a central locking mechanism which controls all drawers and / or receding doors. For additional safety, all lateral files are equipped with an interlock mechanism which prevents more than one drawer or shelf to be opened at a time.

S-series lateral file

please specify:

- model number
- enamel color
- optional drawers (if applicable)

see also:

- lateral file accessories (page 204)
- over-files (page 206)

S-series lateral file

S-series lateral files feature an interlock system which allows only one drawer to be opened at a time. Comes standard with brushed metal pulls and front-to-back letter filing – option DHF (see next page for other options).

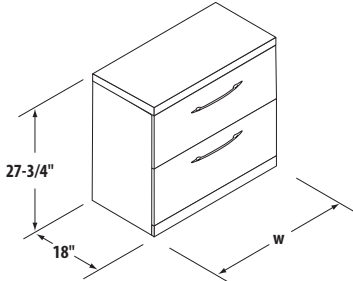

2 drawer lateral file –

May be used alone, placed beneath 29" or higher worksurfaces or used to support worksurfaces.

Counterweights recommended for freestanding use (see page 207).

no lock

model #	w	lbs	list price
S30-200	30"	115	\$898
S36-200	36"	128	950
S42-200	42"	141	1003

with lock

model #	w	lbs	list price
S30-201	30"	118	\$935
S36-201	36"	131	990
S42-201	42"	144	1045

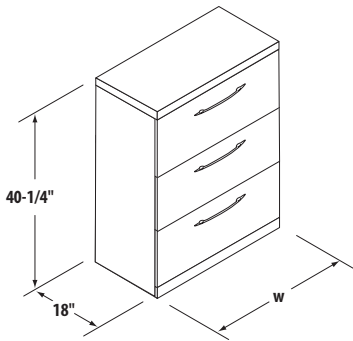

3 drawer lateral file

Counterweights recommended for freestanding use (see page 207).

no lock

model #	w	lbs	list price
S30-300	30"	155	\$1373
S36-300	36"	172	1426
S42-300	42"	189	1478

with lock

model #	w	lbs	list price
S30-301	30"	159	\$1430
S36-301	36"	176	1485
S42-301	42"	193	1540

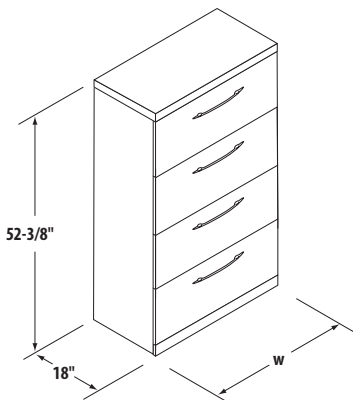

4 drawer lateral file

no lock

model #	w	lbs	list price
S30-400	30"	193	\$1848
S36-400	36"	214	1901
S42-400	42"	235	1954

with lock

model #	w	lbs	list price
S30-401	30"	198	\$1925
S36-401	36"	219	1980
S42-401	42"	240	2035



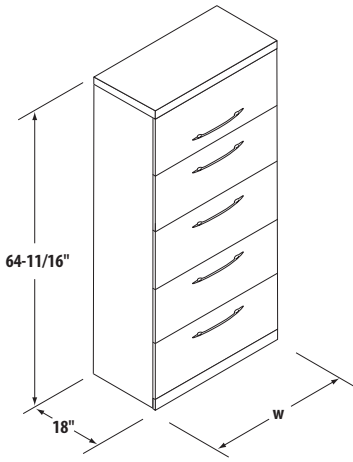

5 drawer lateral file—

Comes with receding door and roll-out shelf at top opening.

Note: top roll-out shelf can be substituted with a drawer at no upcharge. Please specify: "drawers all openings"

no lock

model #	w	lbs	list price
S30-500	30"	234	\$2107
S36-500	36"	259	2167
S42-500	42"	284	2227

with lock

model #	w	lbs	list price
S30-501	30"	240	\$2195
S36-501	36"	265	2257
S42-501	42"	290	2320

standard drawer –

hanging—
front-to-back **letter** filing

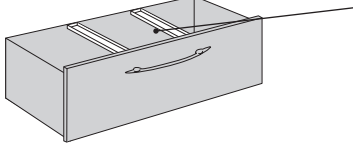

Note: hanging folder bars are field removable for side-to-side legal filing and adjustable for letter or legal front-to-back filing.

standard shelf (top opening 5 drawer) –

hanging—
front-to-back **letter** filing

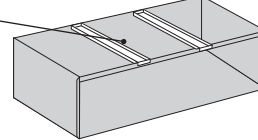

optional drawers – add drawer option as a separate line item. **example:** 1 –S30-201 \$935
2 –SDHFL-30 \$64 + \$64

hanging—
side-to-side **legal** filing

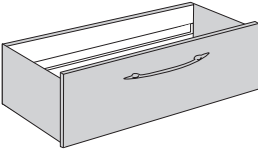

hanging—
side-to-side **letter** filing

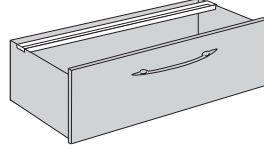

divider (42" drawer only)
front-to-back **letter** filing

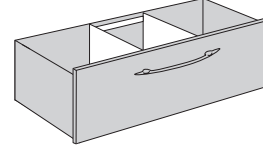

model #	w	lbs	list price
SDHFC-30	30"	2	N/C
SDHFC-36	36"	2	N/C
SDHFC-42	42"	2	N/C

model #	w	lbs	list price
SDHFL-30	30"	2	\$64
SDHFL-36	36"	2	64
SDHFL-42	42"	2	64

model #	w	lbs	list price
SOC1-42	42"	4	\$64

roll-out shelves can be placed in any or all openings.

roll-out shelf options – price includes receding door. Add drawer option as a separate line item. **example:** 1 –S42-401 \$2035
4 –SSHFC-42 \$240 + \$240 + \$240 + \$240

receding door—
comes with roll-out shelf options

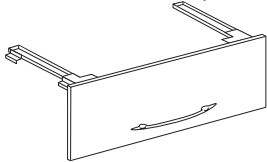

hanging—
side-to-side **legal** filing

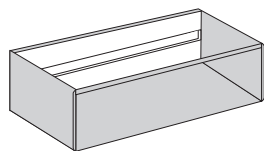

hanging—
side-to-side **letter** filing

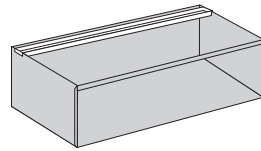

hanging—
front-to-back **letter** filing

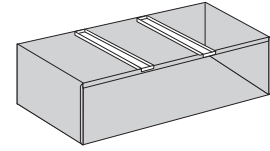

model #	w	lbs	list price
SSHFC-30	30"	2	\$240
SSHFC-36	36"	2	240
SSHFC-42	42"	2	240

model #	w	lbs	list price
SSHFL-30	30"	4	\$308
SSHFL-36	36"	4	308
SSHFL-42	42"	4	308

model #	w	lbs	list price
SSHFC-30	30"	4	\$240
SSHFC-36	36"	4	240
SSHFC-42	42"	4	240



please specify:

- model number
- enamel color
- optional drawers (if applicable)

see also:

- lateral file accessories (page 204)
- over-files (page 206)

P-series lateral file

P-series lateral files feature an interlock system which allows only one drawer to be opened at a time. Comes standard with recessed pulls and front-to-back letter filing – option DHF (see next page for other options).

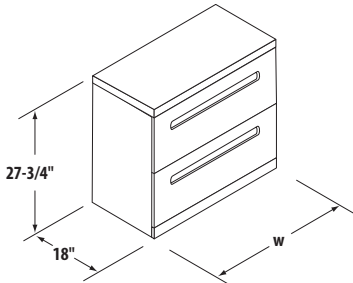

2 drawer lateral file –

May be used alone, placed beneath 29" or higher worksurfaces or used to support worksurfaces.

Counterweights recommended for freestanding use (see page 207).

	model #	w	lbs	list price
no lock	P30-200	30"	115	\$898
	P36-200	36"	128	950
	P42-200	42"	141	1003

	model #	w	lbs	list price
with lock	P30-201	30"	118	\$935
	P36-201	36"	131	990
	P42-201	42"	144	1045

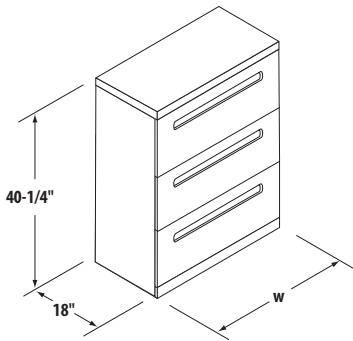

3 drawer lateral file

Counterweights recommended for freestanding use (see page 207).

	model #	w	lbs	list price
no lock	P30-300	30"	155	\$1373
	P36-300	36"	172	1426
	P42-300	42"	189	1478

	model #	w	lbs	list price
with lock	P30-301	30"	159	\$1430
	P36-301	36"	176	1485
	P42-301	42"	193	1540

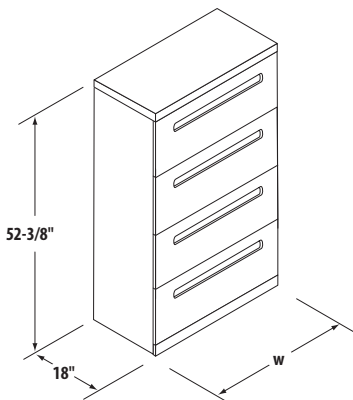

4 drawer lateral file

	model #	w	lbs	list price
no lock	P30-400	30"	193	\$1848
	P36-400	36"	214	1901
	P42-400	42"	235	1954

	model #	w	lbs	list price
with lock	P30-401	30"	198	\$1925
	P36-401	36"	219	1980
	P42-401	42"	240	2035



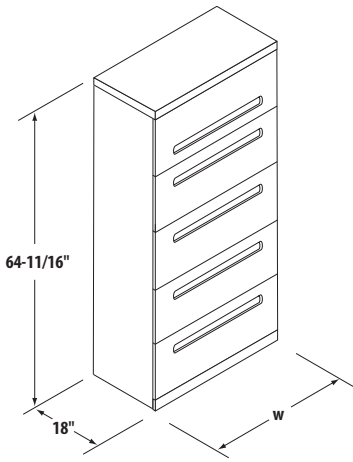

5 drawer lateral file—

Comes with receding door and roll-out shelf at top opening.

Note: top roll-out shelf can be substituted with a drawer at no upcharge. Please specify: "drawers all openings"

no lock

model #	w	lbs	list price
P30-500	30"	234	\$210
P36-500	36"	259	2167
P42-500	42"	284	2227

with lock

model #	w	lbs	list price
P30-501	30"	240	\$2195
P36-501	36"	265	2257
P42-501	42"	290	2600

standard drawer –

hanging—
front-to-back **letter** filing

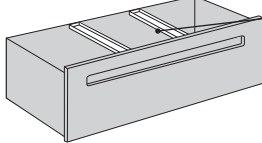

Note: hanging folder bars are field removable for side-to-side legal filing and adjustable for letter or legal front-to-back filing.

standard shelf (top opening 5 drawer) –

hanging—
front-to-back **letter** filing

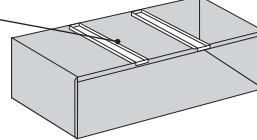

optional drawers – add drawer option as a separate line item. **example:** 1 –P30-201 \$935
2 –PDHFL-30 \$64 + \$64

hanging—
side-to-side **legal** filing

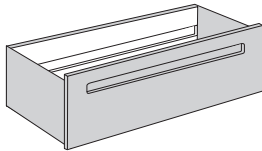

hanging—
side-to-side **letter** filing

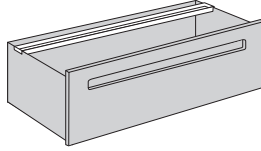

divider (42" drawer only)
front-to-back **letter** filing

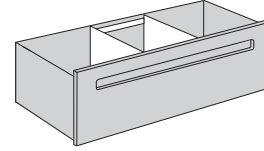

model #	w	lbs	list price
PDHFC-30	30"	2	N/C
PDHFC-36	36"	2	N/C
PDHFC-42	42"	2	N/C

model #	w	lbs	list price
PDHFL-30	30"	2	\$64
PDHFL-36	36"	2	64
PDHFL-42	42"	2	64

model #	w	lbs	list price
POC1-42	42"	4	\$64

roll-out shelves can be placed in any or all openings.

roll-out shelf options – price includes receding door. Add drawer option as a separate line item. **example:** 1 –P42-401 \$2035
4 –PSHF-42 \$240 + \$240 + \$240 + \$240

receding door—
comes with roll-out shelf options

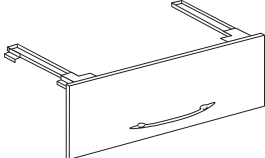

hanging—
side-to-side **legal** filing

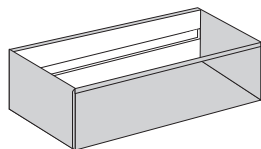

hanging—
side-to-side **letter** filing

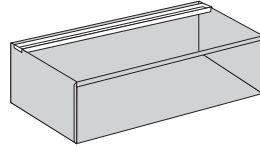

hanging—
front-to-back **letter** filing

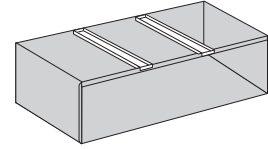

model #	w	lbs	list price
PSHFC-30	30"	2	\$240
PSHFC-36	36"	2	240
PSHFC-42	42"	2	240

model #	w	lbs	list price
PSHFL-30	30"	4	\$308
PSHFL-36	36"	4	308
PSHFL-42	42"	4	308

model #	w	lbs	list price
PSHF-30	30"	4	\$240
PSHF-36	36"	4	240
PSHF-42	42"	4	240



please specify:

- model number
- laminate (*file tops*)
- edge color
- enamel

see also:

- *Laminate Selection Guide*

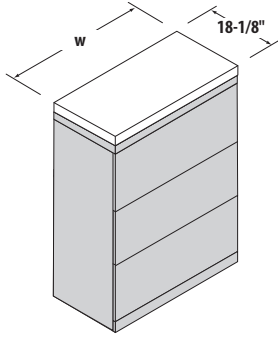

single file top

model #	w	lbs	"B" (banded)
BT-3018	30-1/8"	21	\$275
BT-3618	36-1/8"	24	283
BT-4218	42-1/8"	27	349

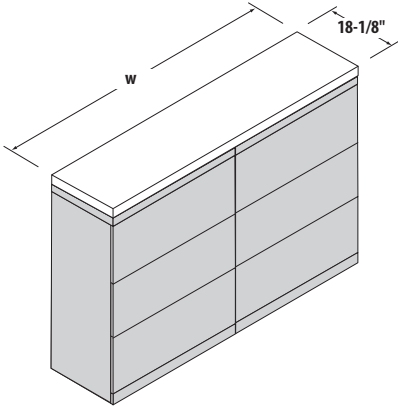

multiple file top

model #	w	lbs	"B" (banded)
BT-6018	60-1/8"	36	\$406
BT-6618	66-1/8"	40	496
BT-7218	72-1/8"	44	530
BT-7818	78-1/8"	49	623
BT-8418	84-1/8"	54	696

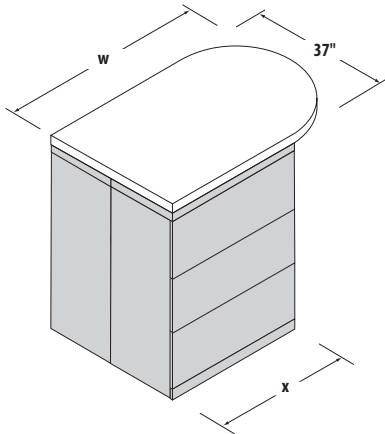

short peninsula –

Attaches to 2 ea. 3-drawer lateral files assembled back-to-back. Creates a standing height meeting/project center.

model #	w	lbs	"B" (banded)
PB-4837	48"	53	\$762
PB-5437	54"	59	853
PB-6037	60"	67	914

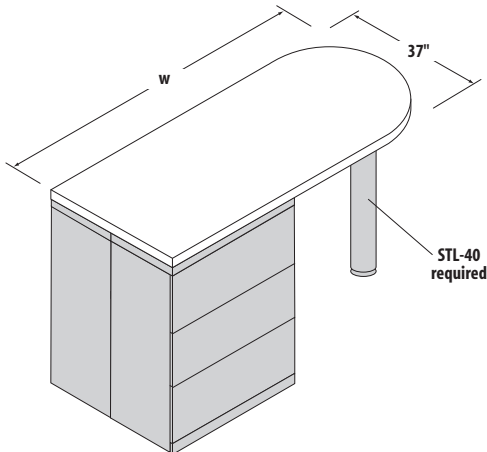

long peninsula

model #	w	lbs	"B" (banded)
PB-6637	66"	73	\$1028
PB-7237	72"	79	1135
PB-7837	78"	85	1443
PB-8437	84"	91	1483

standing height tube leg

model #	h	lbs	list price
STL-40	40"	20	\$275



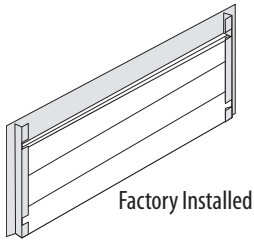

Factory Installed

counterweights –

Counterweights fit into guides on the inside of the file cabinet (*just behind the bottom drawer*).

Recommended for freestanding use on all files to prevent tipping. Price includes 6ea. plates (3 high and 2 deep).

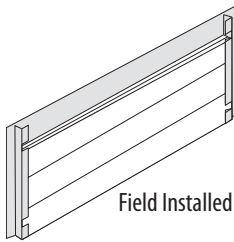

Field Installed

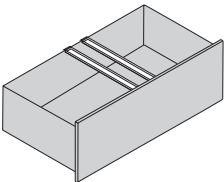

hanging folder crossbar –
for front-to-back filing.

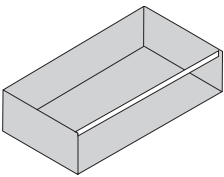

hanging folder frontbar –
Roll-out shelf only.

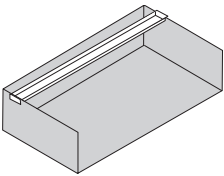

hanging folder back bar –
for side-to-side letter filing.

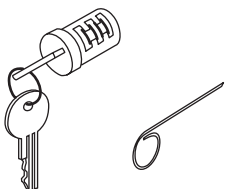

additional lock core, keys & pick – field installation only. Includes core, pick and two keys (*keyed random or specify #*)

additional key – specify lock number when ordering.

2, 3, & 4 drawer files

model #	file width	lbs	list price
CW-30	30"	47	\$317
CW-36	36"	58	372
CW-42	42"	69	414

5 drawer files

model #	file width	lbs	list price
5CW-30	30"	62	\$409
5CW-36	36"	77	439
5CW-42	42"	92	529

2, 3, & 4 drawer files

model #	file width	lbs	list price
FCW-30	30"	50	\$390
FCW-36	36"	61	439
FCW-42	42"	72	484

5 drawer files

model #	file width	lbs	list price
F5CW-30	30"	66	\$475
F5CW-36	36"	81	534
F5CW-42	42"	96	592

model #	lbs	list price
HFB-F	1	\$23 ea.

model #	lbs	list price
HFB-30	1.25	\$23
HFB-36	1.5	23
HFB-42	1.75	23

model #	file width	lbs	list price
HFBB-30	30"	2	\$64
HFBB-36	36"	2	64
HFBB-42	42"	2	64

model #	lbs	list price
LC-1	4oz	\$38

model #	lbs	list price
KO-F	2oz	\$23



**lateral file
over-file storage**

please specify:
• model number
• enamel

single over-file – with sliding doors.

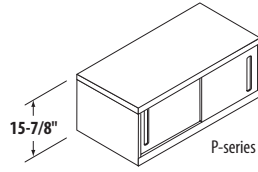
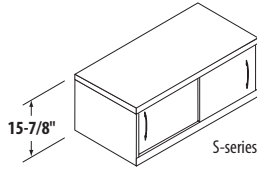

no lock	model #	model #	file width	d	lbs	list price
	S30-1618D	P30-1618D	30"	18"	53	\$718
	S36-1618D	P36-1618D	36"	18"	58	762
	S42-1618D	P42-1618D	42"	18"	68	813

with lock	model #	model #	file width	d	lbs	list price
	S30-1618DL	P30-1618DL	30"	18"	53	\$802
	S36-1618DL	P36-1618DL	36"	18"	58	845
	S42-1618DL	P42-1618DL	42"	18"	68	896

double over-file – with sliding doors and one adjustable shelf.

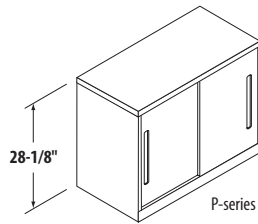
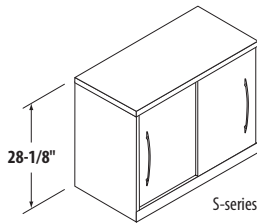

no lock	model #	model #	file width	d	lbs	list price
	S30-2818D	P30-2818D	30"	18"	78	\$1124
	S36-2818D	P36-2818D	36"	18"	84	1176
	S42-2818D	P42-2818D	42"	18"	90	1217

with lock	model #	model #	file width	d	lbs	list price
	S30-2818DL	P30-2818DL	30"	18"	78	\$1210
	S36-2818DL	P36-2818DL	36"	18"	84	1259
	S42-2818DL	P42-2818DL	42"	18"	90	1300



please specify:

- model number
- enamel

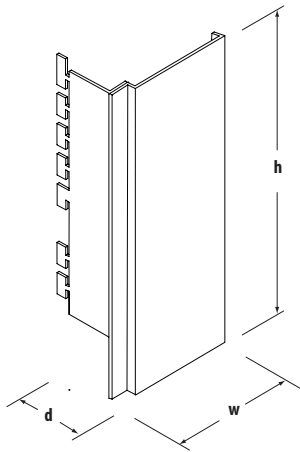

simon side mount anchor brackets –

attach to cantilever slots in Simon panel at any height on the panel. Anchors lateral file to panel with four sheet metal screws (included). Screws terminate in the air space on the backside of the bracket and will not penetrate panel. Fabricated from 12GA (.100) and 18GA (.045) cold rolled steel.

Model #	w	d	h	lbs	list price
SAB	5"	2-1/8"	7-1/2"	2	\$95/pr

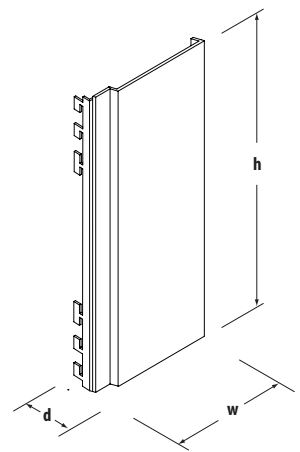

QuB side mount anchor brackets –

attach to cantilever slots in QuB panel at any height on the panel. Anchors lateral file to panel with four sheet metal screws (included). Screws terminate in the air space on the backside of the bracket and will not penetrate panel. Fabricated from 12GA (.100) and 18GA (.045) cold rolled steel.

Model #	w	d	h	lbs	list price
QAB	5"	1-1/8"	7-1/2"	1.5	\$95/pr

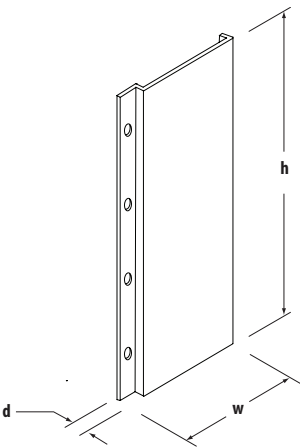

universal side mount anchor brackets –

attach to cantilever slots in any panel with sheet metal screws. Anchors lateral file to panel with four sheet metal screws (included). Screws terminate in the air space on the backside of the bracket and will not penetrate panel. Fabricated from 18GA (.045) cold rolled steel.

Model #	w	d	h	lbs	list price
UAB	5"	1/2"	7-1/2"	1	\$95/pr



**norwalk
vertical file**

please specify:

- model number
- enamel color

see also:

- vertical file options (page 210)

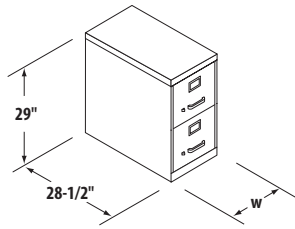

2 drawer vertical file –

Norwalk vertical files come standard with **high-sided drawers** to accommodate hanging folders.

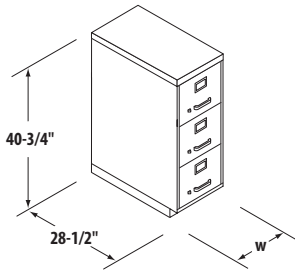

**3 drawer “toe space”
vertical file –**

Available without toe space base at no charge (please specify “minus base”).

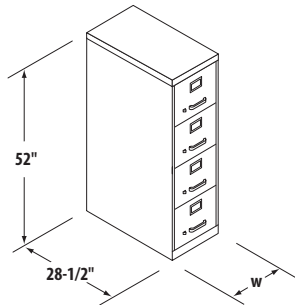

4 drawer vertical file

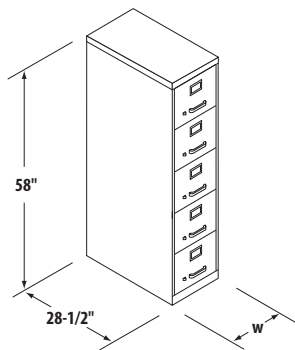

5 drawer vertical file

letter width

model #	w	lbs	list price
no lock 1200	15"	91	\$739
with lock 1201	15"	93	770

legal width

model #	w	lbs	list price
no lock 1202	18"	100	\$771
with lock 1203	18"	102	803

letter width

model #	w	lbs	list price
no lock 1300	15"	132	\$950
with lock 1301	15"	134	990

legal width

model #	w	lbs	list price
no lock 1302	18"	144	\$1014
with lock 1303	18"	146	1056

letter width

model #	w	lbs	list price
no lock 1400	15"	166	\$1162
with lock 1401	15"	169	1210

legal width

model #	w	lbs	list price
no lock 1402	18"	180	\$1257
with lock 1403	18"	183	1309

letter width

model #	w	lbs	list price
no lock 1500	15"	194	\$1312
with lock 1501	15"	196	1367

legal width

model #	w	lbs	list price
no lock 1502	18"	204	\$1420
with lock 1503	18"	206	1479



P-series vertical file

please specify:

- model number
- enamel color

see also:

- vertical file options (page 210)

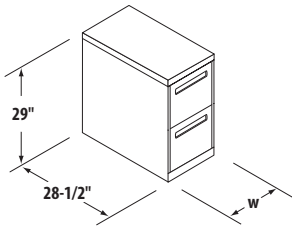

2 drawer vertical file –

P-series vertical files come standard with **high-sided drawers** to accommodate hanging folders.

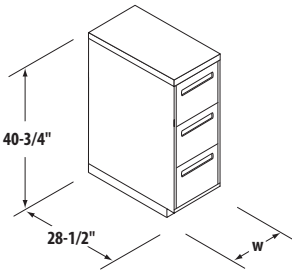

3 drawer “toe space” vertical file –

Available without toe space base at no charge (please specify “minus base”).

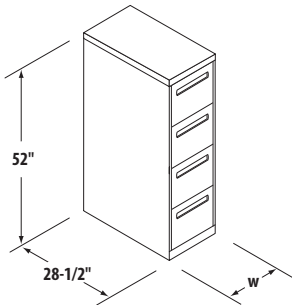

4 drawer vertical file

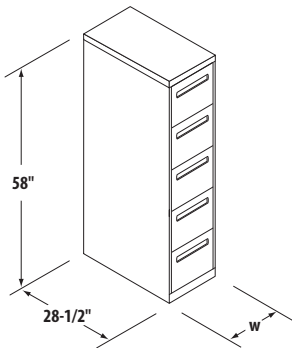

5 drawer vertical file

letter width

	model #	w	lbs	list price
no lock	P-1200	15"	91	\$739
with lock	P-1201	15"	93	770

legal width

	model #	w	lbs	list price
no lock	P-1202	18"	100	\$771
with lock	P-1203	18"	102	803

letter width

	model #	w	lbs	list price
no lock	P-1300	15"	132	\$950
with lock	P-1301	15"	134	990

legal width

	model #	w	lbs	list price
no lock	P-1302	18"	144	\$1014
with lock	P-1303	18"	146	1056

letter width

	model #	w	lbs	list price
no lock	P-1400	15"	166	\$1162
with lock	P-1401	15"	169	1210

legal width

	model #	w	lbs	list price
no lock	P-1402	18"	180	\$1257
with lock	P-1403	18"	183	1309

letter width

	model #	w	lbs	list price
no lock	P-1500	15"	194	\$1312
with lock	P-1501	15"	196	1367

legal width

	model #	w	lbs	list price
no lock	P-1502	18"	204	\$1420
with lock	P-1503	18"	206	1479



vertical file accessories & drawer options

please specify:

- model number
- laminate (*file tops*)
- factory installation (*file tops*)

see also:

- *Laminate Selection Guide*

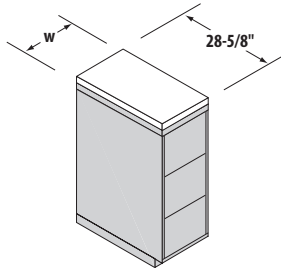

vertical file top

model #	w	lbs	"B" Banded
BT-1528	15" (letter)	19	\$275
BT-1828	18" (legal)	23	299

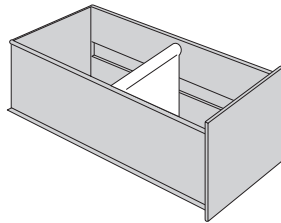

high-sided / dual-function drawer –

For hanging folder filing and compressor filing. Specify as a separate line item.

Example: 1-1401 = \$1210
4-DFD-L = \$70 + \$70 + \$70 + \$70

model #	w	lbs	list price
DFD-L	12" (letter)	5	\$70
DFD-C	15" (legal)	6	75

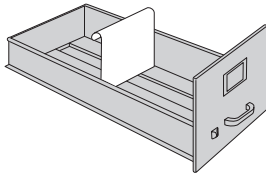

optional drawer compressor –

specify as a separate line item.

Example: 1-1201 = \$770
2-COM-L = \$41 + \$41

model #	w	lbs	list price
COM-L	12" (letter)	2	\$41
COM-C	15" (legal)	2	41

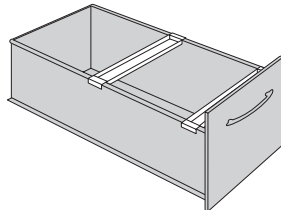

dual hanging cross bars –

file drawer option. Converts letter to side-to-side legal. High sided drawer only.

model #	lbs	list price
F-HFB-C	1	\$41

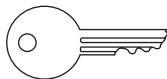

additional key –

specify lock number when ordering

model #	lbs	list price
KO-F	2oz	\$23



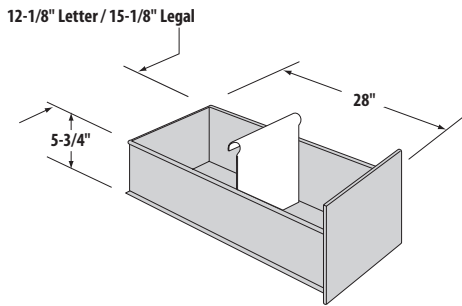

compressor drawer

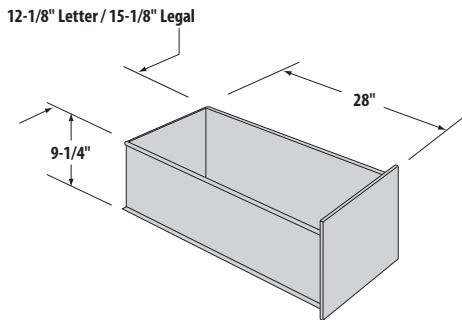

high sided & dual function drawer

please specify:

- model number
- enamel color

steel bookcases

Heavy gauge, double wall construction. Welded and brazed on all eight-corners. Multi-formed steel shelves adjust on 1/2" increments and hold up under heavy loads. Simply put, these steel bookcases are the finest anywhere. Bookcases come standard with height adjustable shelf(s) (additional shelves available - see next page).

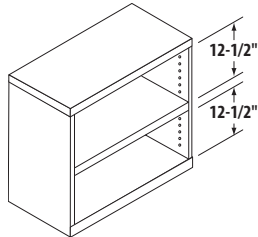

2 shelf –
fixed bottom and 1ea. adjustable shelf included. 12-1/2" high shelf space. Adjustable glides.

model #	w	d	h	lbs	list price
BC-3630	35"	13-5/8"	30"	46	\$527

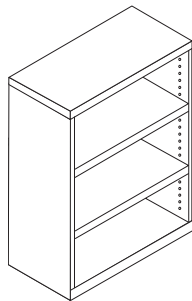

3 shelf –
fixed bottom and 2ea. adjustable shelves included. 12-1/2" high shelf space. Adjustable glides.

model #	w	d	h	lbs	list price
BC-3643	35"	13-5/8"	43-1/2"	66	\$655

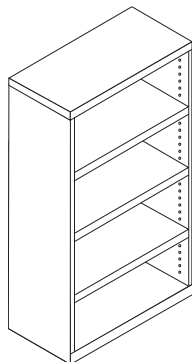

4 shelf –
fixed bottom and 3ea. adjustable shelves included. 12-1/2" high shelf space. Adjustable glides.

model #	w	d	h	lbs	list price
BC-3657	35"	13-5/8"	57"	87	\$839

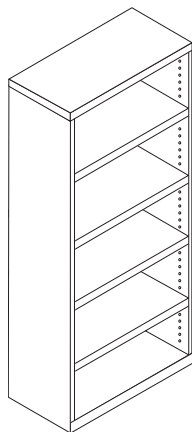

5 shelf –
fixed bottom and 4ea. adjustable shelves included. 12-1/2" high shelf space. Adjustable glides.

model #	w	d	h	lbs	list price
BC-3670	35"	13-5/8"	70-1/2"	107	\$1066



please specify:

- model number
- enamel color
- laminate (top)

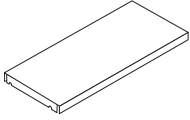

additional shelf –
mounting brackets included.

<i>model #</i>	<i>shelf width</i>	<i>lbs</i>	<i>list price</i>
BC-SHELF	33"	5	\$68

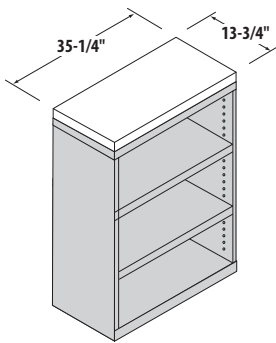

bookcase top –
specify laminate.

<i>model #</i>	<i>description</i>	<i>lbs</i>	<i>list price</i>
BT-3514	banded-edge laminate bookcase top	16	\$256

<i>model #</i>	<i>description</i>	<i>lbs</i>	<i>list price</i>
BA-1	bookcase wall mount bracket (1 pair per bookcase)	1	\$28













mcdowellcraig.com

13146 Firestone Blvd., Santa Fe Springs, California 90670 • Phone: 562.921.4441 • Fax: 562.921.9648